

Haryana Rail Infrastructure Development Corporation Limited

(A Joint Venture Govt. of Haryana and Ministry of Railways)

Plot no.143, Railtel Tower, Sector-44, Floor/ Room number: 5th floor, City: Gurugram,

Zip code: 122003, Country: INDIA

Telephone: +91 7011056770, E-mail: horc.etendering@gmail.com , Website: www.hridc.co.in

Tender No. HORC/HRIDC/PSC-01/2023

Date 10.11.2023

Reference: Specific Procurement Notice dated 07.10.2023.

CORRIGENDUM No. 2

Name of Work: **PSC-01:** Manufacture and Supply of Pre-stressed Mono Block Concrete Line Sleepers conforming to RDSO Drg. No. T-8746 in connection with laying of New BG Double Railway Line from Prithla to New Harsana Kalan of Haryana Orbital Rail Corridor (HORC) Project.

The E-tender No. 2023_HBC_319474_1 for the above mentioned Work was published on 10.10.2023.

Final Tender Document is hereby issued with Corrigendum No. 2 incorporating the modifications carried out vide Corrigendum No. 1 dated 06.11.2023.

Tenderers are advised to download Final Tender Document issued vide Corrigendum No. 2 on eProcurement portal of Govt. of Haryana (<https://etenders.hry.nic.in>) and submit their Tender based on the requirements of Final Tender Document.

In case of any discrepancy noticed at any stage i.e. evaluation of Tenders, execution of the Works or final payment of the Contract, the contents of Final Tender Document shall supersede previously issued Tender Document dated 10.10.2023 and Corrigendum No. 1.

--SD--

GM/IP&IT,

Haryana Rail Infrastructure

Development Corporation Limited Plot

No 143, 5th Floor, RailTel Tower,

Sector- 44, Gurugram,

Haryana-122003

Tel No: +917011056770

Email Id: horc.etendering@gmail.com

Final Tender Document for Goods
(Two Envelope Tendering Process)

Procurement of:

PSC-01: Manufacture and Supply of Pre-stressed Mono Block Concrete Line Sleepers conforming to RDSO Drg. No. T-8746 in connection with laying of New BG Double Railway Line from Prithla to New Harsana Kalan of Haryana Orbital Rail Corridor (HORC) Project.

Tender No: HORC/HRIDC/PSC- 01/2023

Project: Haryana Orbital Rail Corridor (HORC) Project

Project No.: 000741

Purchaser: Haryana Orbital Rail Corridor Limited (HORCL)

Country: INDIA

Issued on: 10.11.2023

Summary

Specific Procurement Notice (SPN)

PART 1 – TENDERING PROCEDURES

- Section I - Instructions to Tenderers (ITT)
- Section II - Tender Data Sheet (TDS)
- Section III - Evaluation and Qualification Criteria
- Section IV - Tender Forms
- Section V - Eligible Countries
- Section VI - Prohibited Practices

PART 2 – SUPPLY REQUIREMENTS

- Section VII – Schedule of Requirements

PART 3 – CONDITIONS OF CONTRACT AND CONTRACT FORMS

- Section VIII - General Conditions of Contract (GCC)
- Section IX - Special Conditions of Contract (SCC)
- Section X - Contract Forms

Contents

PART 1 – Tendering Procedures 3

Section I - Instructions to Tenderers5

Section II - Tender Data Sheet (TDS)..... 33

Section III - Evaluation and Qualification Criteria 53

Section IV - Tender Forms69

Section V - Eligible Countries 109

Section VI - Prohibited Practices 111

PART 1 – Tendering Procedures

Page Intentionally Left Blank

Section I - Instructions to Tenderers

Contents

A. General.....	7
1. Scope of Tender.....	7
2. Source of Funds.....	7
3. Prohibited Practices.....	8
4. Eligible Tenderers.....	8
5. Eligible Goods and Related Services.....	11
B. Contents of Tender Document.....	11
6. Sections of Tender Document.....	11
7. Clarification of Tender Document.....	12
8. Amendment of Tender Document.....	12
C. Preparation of Tenders.....	12
9. Cost of Tendering.....	12
10. Language of Tender.....	13
11. Documents Comprising the Tender.....	13
12. Letter of Tender and Price Schedules.....	14
13. Alternative Tenders.....	14
14. Tender Prices and Discounts.....	14
15. Currencies of Tender and Payment.....	16
16. Documents Establishing the Eligibility and Conformity of the Goods and Related Services.....	16
17. Documents Establishing the Eligibility and Qualifications of the Tenderer.....	17
18. Period of Validity of Tenders.....	17
19. Tender Security.....	18
20. Format and Signing of Tender.....	19
D. Submission and Opening of Tenders.....	21
21. Sealing and Marking of Tenders.....	21
22. Deadline for Submission of Tenders.....	21
23. Late Tenders.....	21
24. Withdrawal, Substitution and Modification of Tenders.....	22
25. Tender Opening.....	22
E. Evaluation and Comparison of Tenders.....	23
26. Confidentiality.....	23
27. Clarification of Tenders.....	24
28. Deviations, Reservations and Omissions.....	24
29. Determination of Responsiveness.....	24
30. Nonmaterial Nonconformities.....	25
31. Correction of Arithmetical Errors.....	25

32.	Conversion to Single Currency	26
33.	Provisions for Development of Domestic Industry.....	26
34.	Evaluation of Tenders	26
35.	Comparison of Tenders.....	27
36.	Abnormally Low-Priced Tenders	28
37.	Post-Qualification of the Tenderer.....	28
38.	Purchaser’s Right to Accept Any Tender and to Reject Any or All Tenders.....	29
39.	Standstill Period.....	29
40.	Notification of Intention to Award.....	29
	F. Award of Contract	29
41.	Award Criteria.....	30
42.	Purchaser’s Right to Vary Quantities at Time of Award	30
43.	Notification of Award.....	30
44.	Debriefing by the Purchaser	31
45.	Signing of Contract	31
46.	Performance Security	32
47.	Procurement-Related Complaint	32

Section I. Instructions to Tenderers

A. General

- 1. Scope of Tender**
- 1.1 In connection with the Specific Procurement Notice (SPN) indicated in the **Tender Data Sheet (TDS)**, the Purchaser, as specified in the **TDS**, issues this Tender Document for the supply of Goods and, if applicable, any Related Services incidental thereto, as specified in Section VII, Schedule of Requirements. The name, identification and number of lots (contracts) of this tender are specified in the **TDS**.
- 1.2 Throughout this Tender Document:
- (a) the term “in writing” means communicated in written form (e.g., by mail, e-mail, fax, including if specified in the **TDS**, distributed or received through the electronic procurement system used by the Purchaser) with proof of receipt;
 - (b) if the context so requires, “singular” means “plural” and vice versa;
 - (c) “Day” means calendar day, unless otherwise specified as “Business Day.” A Business Day is any day that is an official working day of the Recipient. It excludes the Recipient’s official public holidays; and
 - (d) the word “tender” is synonymous with “bid” and “tenderer” with “bidder”, and the words “tender documents” with “bidding documents.”
- 2. Source of Funds**
- 2.1 The Recipient specified in the **TDS** has applied for or received financing (hereinafter called “funds”) from the Asian Infrastructure Investment Bank (hereinafter called “AIIB” or “the Bank”) in an amount specified in the **TDS**, toward the project named in the **TDS**. The Recipient intends to apply a portion of the funds to eligible payments under the contract for which this Tender Document is issued.
- 2.2 Payment by the Bank will be made only at the request of the Recipient and upon approval by the Bank in accordance with the terms and conditions of the Loan (or other financing) Agreement. The Loan (or other financing) Agreement prohibits a withdrawal from the Loan account for the purpose of any payment to persons or entities, or for any import of goods, if such payment or import is prohibited by decision of the United Nations Security Council taken under Chapter VII of the Charter of the United Nations. No party other than the Recipient shall derive any rights from the

Loan (or other financing) Agreement or have any claim to the proceeds of the Loan (or other financing).

3. Prohibited Practices

3.1 The Bank requires compliance with the Bank's Policy on Prohibited Practices as set forth in Section VI.

3.2 In further pursuance of this policy, Tenderers shall permit and shall cause their agents (whether declared or not), subcontractors, subconsultants, service providers, suppliers and their personnel, to permit the Bank to inspect all accounts, records and other documents relating to any initial selection process, prequalification process, tender submission, proposal submission and contract performance (in the case of award), and to have them audited by auditors appointed by the Bank.

4. Eligible Tenderers

4.1 A Tenderer may be a firm that is a private entity, a state-owned enterprise or institution subject to ITT 4.6, or any combination of such entities in the form of a joint venture (JV) under an existing agreement or with the intent to enter into such an agreement supported by a letter of intent. In the case of a JV, all members shall be jointly and severally liable for the execution of the entire Contract in accordance with the Contract terms. The JV shall nominate a Representative who shall have the authority to conduct all business for and on behalf of any and all the members of the JV during the tendering process and, in the event the JV is awarded the Contract, during contract execution. Unless specified in the TDS, there is no limit on the number of members in a JV.

4.2 A Tenderer shall not have a conflict of interest. Any Tenderer found to have a conflict of interest shall be disqualified. A Tenderer may be considered to have a conflict of interest for the purpose of this Tendering process, if the Tenderer:

- (a) directly or indirectly controls, is controlled by or is under common control with another Tenderer; or
- (b) receives or has received any direct or indirect subsidy from another Tenderer; or
- (c) has the same legal representative as another Tenderer; or
- (d) has a relationship with another Tenderer, directly or through common third parties, that puts it in a position to influence the Tender of another Tenderer, or influence the decisions of the Purchaser regarding this tendering process; or
- (e) or any of its affiliates participated as a consultant in the preparation of the design or technical specifications of the Goods that are the subject of the Tender; or

- (f) or any of its affiliates has been hired (or is proposed to be hired) by the Purchaser or Recipient for the Contract implementation; or
 - (g) would be providing goods, works or non-consulting services resulting from or directly related to consulting services for the preparation or implementation of the project specified in the TDS ITT 2.1 that it provided or were provided by any affiliate that directly or indirectly controls, is controlled by, or is under common control with that firm; or
 - (h) has a close business or family relationship with a professional staff of the Recipient (or of the project implementing agency, or of any other beneficiary of the Bank's financing, or of any other party representing or acting on behalf of the Recipient) who: (i) are directly or indirectly involved in the preparation of the Tender Document or specifications of the Contract, and/or the tender evaluation process of such Contract; or (ii) would be involved in the implementation or supervision of such Contract, unless the conflict stemming from such relationship has been resolved in a manner acceptable to the Bank throughout the tendering process and execution of the Contract; or
 - (i) is an affiliate of the Recipient, or of a procurement agent engaged by the Recipient, unless the Recipient demonstrates to the satisfaction of the Bank that there is no significant degree of common ownership, influence or control between the Recipient on the one hand, and the Recipient's agent and the affiliate on the other.
- 4.3 A firm that is a Tenderer (either individually or as a JV member) shall not participate in more than one Tender, except for permitted alternative Tenders. Such participation shall result in the disqualification of all Tenders in which the firm is involved. However, this does not limit: (a) the inclusion of the same Subcontractor in more than one Tender for the same contract; or (b) the ability of one Tenderer to be a Subcontractor in another Tender for the same contract.
- 4.4 A Tenderer may have the nationality of any country, subject to the restrictions pursuant to ITT 4.8. A Tenderer shall be deemed to have the nationality of a country if the Tenderer is constituted, incorporated or registered in and operates in conformity with the provisions of the laws of that country, as evidenced by its articles of incorporation (or equivalent documents of constitution or association) and its registration documents, as the case may be. This criterion also shall apply to the determination of the nationality of

proposed subcontractors or subconsultants for any part of the Contract including related Services.

- 4.5 A Tenderer that has been declared, and remains, as at the relevant date, ineligible pursuant to the Bank's Policy on Prohibited Practices as described in Section VI, shall be ineligible to be prequalified for, initially selected for, tender for, propose for, or be awarded a Bank-financed contract, or benefit from a Bank-financed contract, financially or otherwise, during such period of time as the Bank shall have determined. The list of debarred firms and individuals is available at the electronic address specified in the **TDS**.
- 4.6 Tenderers that are state-owned enterprises or institutions in the Purchaser's Country may be eligible to compete and be awarded a Contract(s) only if they can establish, in a manner acceptable to the Bank, that they (i) are carrying out or are established for a business purpose, and are operating on a commercial basis; (ii) are financially and managerially autonomous; (iii) are not controlled by the government on day-to-day management and (iv) are not under the supervision of the Purchaser or its procuring agency.
- 4.7 A Tenderer shall not be under suspension from tendering by the Purchaser as the result of the operation of a Tender-Securing Declaration or Proposal-Securing Declaration.
- 4.8 Firms and individuals may be ineligible if so indicated in Section V and (a) as a matter of law or official regulations, the Recipient's country prohibits commercial relations with the firm or individual's country, provided that the Bank is satisfied that such exclusion does not preclude effective competition for the supply of goods or the contracting of works or services required; or (b) by an act of compliance with a decision of the United Nations Security Council taken under Chapter VII of the Charter of the United Nations, the Recipient's country prohibits any import of goods or contracting of works or services from the firm or individual's country, or any payments to any country, person or entity in that country.
- 4.9 A Tenderer shall provide such documentary evidence of eligibility satisfactory to the Purchaser, as the Purchaser shall reasonably request.
- 4.10 A firm that is under a sanction of debarment by the Recipient from being awarded a contract is eligible to participate in this procurement, unless the Bank, at the Recipient's request, is satisfied that the debarment:
- (a) relates to fraud or corruption or prohibited practices; and

(b) followed a judicial or administrative proceeding that afforded the firm adequate due process.

- 5. Eligible Goods and Related Services**
- 5.1 All the Goods and Related Services to be supplied under the Contract and financed by the Bank may have their origin in any country subject to the restrictions specified in Section V, Eligible Countries.
- 5.2 For purposes of this ITT, the term “goods” includes commodities, raw material, machinery, equipment and industrial plants; and “related services” includes services such as insurance, installation, training and initial operation and maintenance.
- 5.3 The term “origin” means the country where the goods have been mined, grown, cultivated, produced, manufactured or processed; or, through manufacture, processing or assembly, another commercially recognized article result that differs substantially in its basic characteristics from its components.

B. Contents of Tender Document

- 6. Sections of Tender Document**
- 6.1 The Tender Document consists of Parts 1, 2 and 3, includes all the sections indicated below, and should be read in conjunction with any Addenda issued in accordance with ITT 8.

PART 1 Tendering Procedures

- Section I - Instructions to Tenderers (ITT)
- Section II - Tender Data Sheet (TDS)
- Section III - Evaluation and Qualification Criteria
- Section IV - Tender Forms
- Section V - Eligible Countries
- Section VI - Prohibited Practices

PART 2 Supply Requirements

- Section VII - Schedule of Requirements

PART 3 Conditions of Contract and Contract Forms

- Section VIII - General Conditions of Contract (GCC)
- Section IX - Special Conditions of Contract (SCC)
- Section X - Contract Forms

- 6.2 The Specific Procurement Notice (SPN) issued by the Purchaser is not part of this Tender Document.

- 6.3 Unless obtained directly from the Purchaser, the Purchaser is not responsible for the completeness of the Tender Document, responses to requests for clarification, the Minutes of the pre-tender meeting (if any), or Addenda to the Tender Document in accordance with ITT 8. In case of any contradiction, documents obtained directly from the Purchaser shall prevail.
- 6.4 The Tenderer is expected to examine all instructions, forms, terms and specifications in the Tender Document and to furnish with its Tender all information or documentation as is required by the Tender Document.
- 7. Clarification of Tender Document**
- 7.1 A Tenderer requiring any clarification of the Tender Document shall contact the Purchaser in writing at the Purchaser's address specified in the **TDS**. The Purchaser will respond in writing to any request for clarification, provided that such request is received prior to the deadline for submission of Tenders within a period specified in the **TDS**. The Purchaser shall forward copies of its response to all Tenderers who have acquired the Tender Document in accordance with ITT 6.3, including a description of the inquiry but without identifying its source. If so specified in the **TDS**, the Purchaser shall also promptly publish its response at the web page identified in the **TDS**. Should the clarification result in changes to the essential elements of the Tender Document, the Purchaser shall amend the Tender Document following the procedure under ITT 8 and ITT 22.2.
- 8. Amendment of Tender Document**
- 8.1 At any time prior to the deadline for submission of Tenders, the Purchaser may amend the Tender Document by issuing addenda.
- 8.2 Any addendum issued shall be part of the Tender Document and shall be communicated in writing to all who have obtained the Tender Document from the Purchaser in accordance with ITT 6.3. The Purchaser shall also promptly publish the addendum on the Purchaser's web page in accordance with ITT 7.1.
- 8.3 To give prospective Tenderers reasonable time in which to take an addendum into account in preparing their Tenders, the Purchaser may, at its discretion, extend the deadline for the submission of Tenders, pursuant to ITT 22.2.

C. Preparation of Tenders

- 9. Cost of Tendering**
- 9.1 The Tenderer shall bear all costs associated with the preparation and submission of its Tender, and the Purchaser shall not be responsible or liable for those costs, regardless of the conduct or outcome of the tendering process.

10. Language of Tender

10.1 The Tender, as well as all correspondence and documents relating to the Tender exchanged by the Tenderer and the Purchaser, shall be written in the language specified in the **TDS**. Supporting documents and printed literature that are part of the Tender may be in another language provided they are accompanied by an accurate translation of the relevant passages into the language specified in the **TDS**, in which case, for purposes of interpretation of the Tender, such translation shall govern.

11. Documents Comprising the Tender

11.1 The Tender shall comprise the following:

- (a) **Letter of Tender:** prepared in accordance with ITT 12.
- (b) **Price Schedules:** completed in accordance with ITT 12 and ITT 14.
- (c) **Tender Security or Tender-Securing Declaration:** in accordance with ITT 19.1.
- (d) **Alternative Tender:** if permissible, in accordance with ITT 13.
- (e) **Authorization:** written confirmation authorizing the signatory of the Tender to commit the Tenderer, in accordance with ITT 20.3.
- (f) **Qualifications:** documentary evidence in accordance with ITT 17 establishing the Tenderer's qualifications to perform the Contract if its Tender is accepted.
- (g) **Tenderer's Eligibility:** documentary evidence in accordance with ITT 17 establishing the Tenderer's eligibility to tender.
- (h) **Eligibility of Goods and Related Services:** documentary evidence in accordance with ITT 16, establishing the eligibility of the Goods and Related Services to be supplied by the Tenderer.
- (i) **Conformity:** documentary evidence in accordance with ITT 16 and ITT 30, that the Goods and Related Services conform to the Tender Document.
- (j) Any other document required in the **TDS**.

11.2 In addition to the requirements under ITT 11.1, Tenders submitted by a JV shall include a copy of the JV Agreement entered into by all members. Alternatively, a letter of intent to execute a JV Agreement in the event of a successful Tender shall be signed by all members and submitted with the Tender, together with a copy of the proposed Agreement.

- 11.3 The Tenderer shall furnish in the Letter of Tender information on commissions and gratuities, if any, paid or to be paid to agents or any other party relating to this Tender.
- 12. Letter of Tender and Price Schedules**
- 12.1 The Letter of Tender and Price Schedules shall be prepared using the relevant forms furnished in Section IV, Tender Forms. The forms must be completed without any alterations to the text, and no substitutes shall be accepted except as provided under ITT 20.3. All blank spaces shall be filled in with the information requested.
- 13. Alternative Tenders**
- 13.1 Unless otherwise specified in the **TDS**, alternative Tenders shall not be considered.
- 14. Tender Prices and Discounts**
- 14.1 The prices and discounts quoted by the Tenderer in the Letter of Tender and in the Price Schedules shall conform to the requirements specified below.
- 14.2 All lots (contracts) and items must be listed and priced separately in the Price Schedules.
- 14.3 The price to be quoted in the Letter of Tender in accordance with ITT 12.1 shall be the total price of the Tender, excluding any discounts offered.
- 14.4 The Tenderer shall quote any discounts and indicate the methodology for their application in the Letter of Tender, in accordance with ITT 12.1.
- 14.5 Prices quoted by the Tenderer shall be fixed during the Tenderer's performance of the Contract and not subject to variation on any account, unless otherwise specified in the **TDS**. A Tender submitted with an adjustable price quotation shall be treated as nonresponsive and shall be rejected, pursuant to ITT 29. However, if in accordance with the **TDS**, prices quoted by the Tenderer shall be subject to adjustment during the performance of the Contract, a Tender submitted with a fixed price quotation shall not be rejected, but the price adjustment shall be treated as zero.
- 14.6 If so specified in ITT 1.1, Tenders are being invited for individual lots (contracts) or for any combination of lots (packages). Unless otherwise specified in the **TDS**, prices quoted shall correspond to 100 percent of the items specified for each lot and to 100 percent of the quantities specified for each item of a lot. Tenderers wishing to offer discounts for the award of more than one Contract shall specify in their Tender the price reductions applicable to each package, or alternatively, to individual Contracts within the package. Discounts shall be submitted in accordance with ITT 14.4 provided the Tenders for all lots (contracts) are opened at the same time.

- 14.7 The terms EXW, CIP and other similar terms shall be governed by the rules prescribed in the current edition of Incoterms, published by the International Chamber of Commerce, as specified in the **TDS**.
- 14.8 Prices shall be quoted as specified in each Price Schedule included in Section IV, Tender Forms. The disaggregation of price components is required solely for the purpose of facilitating the comparison of Tenders by the Purchaser. This shall not in any way limit the Purchaser's right to contract on any of the terms offered. In quoting prices, the Tenderer shall be free to use transportation through carriers registered in any eligible country, in accordance with Section V, Eligible Countries. Similarly, the Tenderer may obtain insurance services from any eligible country in accordance with Section V, Eligible Countries. Prices shall be entered in the following manner:
- (a) For Goods manufactured in the Purchaser's Country:
 - (i) the price of the Goods quoted EXW (ex-works, ex-factory, ex-warehouse, ex-showroom or off-the-shelf, as applicable), including all customs duties and sales and other taxes already paid or payable on the components and raw material used in the manufacture or assembly of the Goods;
 - (ii) any Purchaser's Country sales tax and other taxes which will be payable on the Goods if the Contract is awarded to the Tenderer; and
 - (iii) the price for inland transportation, insurance and other local services required to convey the Goods to their final destination (Project Site) specified in the **TDS**.
 - (b) For Goods manufactured outside the Purchaser's Country, to be imported:
 - (i) the price of the Goods, quoted CIP named place of destination, in the Purchaser's Country, as specified in the **TDS**; and
 - (ii) the price for inland transportation, insurance and other local services required to convey the Goods from the named place of destination to their final destination (Project Site) specified in the **TDS**.
 - (c) For Goods manufactured outside the Purchaser's Country, already imported:
 - (i) the price of the Goods, including the original import value of the Goods; plus any mark-up (or rebate); plus any other related local cost, and custom duties and

- other import taxes already paid or to be paid on the Goods already imported;
- (ii) the custom duties and other import taxes already paid (need to be supported with documentary evidence) or to be paid on the Goods already imported;
 - (iii) the price of the Goods, obtained as the difference between (i) and (ii) above;
 - (iv) any Purchaser's Country sales and other taxes which will be payable on the Goods if the Contract is awarded to the Tenderer; and
 - (v) the price for inland transportation, insurance and other local services required to convey the Goods from the named place of destination to their final destination (Project Site) specified in the **TDS**.
- (d) For Related Services, other than inland transportation and other services required to convey the Goods to their final destination, whenever such Related Services are specified in the Schedule of Requirements, the price of each item comprising the Related Services (inclusive of any applicable taxes).
- 15. Currencies of Tender and Payment**
- 15.1 The currency(ies) of the Tender and the currency(ies) of payments shall be the same and shall be as specified in the **TDS**.
- 16. Documents Establishing the Eligibility and Conformity of the Goods and Related Services**
- 16.1 To establish the eligibility of the Goods and Related Services in accordance with ITT 5, Tenderers shall complete the country-of-origin declarations in the Price Schedule Forms, included in Section IV, Tender Forms.
- 16.2 To establish the conformity of the Goods and Related Services to the tendering document, the Tenderer shall furnish as part of its Tender the documentary evidence that the Goods conform to the technical specifications and standards specified in Section VII, Schedule of Requirements.
- 16.3 The documentary evidence may be in the form of literature, drawings or data, and shall consist of a detailed item by item description of the essential technical and performance characteristics of the Goods and Related Services, demonstrating substantial responsiveness of the Goods and Related Services to the technical specification, and if applicable, a statement of deviations and exceptions to the provisions of the Section VII, Schedule of Requirements.
- 16.4 The Tenderer shall also furnish a list giving full particulars, including available sources and current prices of spare parts,

special tools, etc., necessary for the proper and continuing functioning of the Goods during the period specified in the **TDS** following commencement of the use of the Goods by the Purchaser.

16.5 Standards for workmanship, process, material and equipment, as well as references to brand names or catalogue numbers specified by the Purchaser in the Schedule of Requirements, are intended to be descriptive only and not restrictive. The Tenderer may offer other standards of quality, brand names and/or catalogue numbers, provided that it demonstrates, to the Purchaser's satisfaction, that the substitutions ensure substantial equivalence or are superior to those specified in the Section VII, Schedule of Requirements.

**17. Documents
Establishing the
Eligibility and
Qualifications of
the Tenderer**

17.1 To establish Tenderer's eligibility in accordance with ITT 4, Tenderers shall complete the Letter of Tender, included in Section IV, Tender Forms.

17.2 The documentary evidence of the Tenderer's qualifications to perform the Contract if its Tender is accepted shall establish to the Purchaser's satisfaction:

- (a) that, if required in the **TDS**, a Tenderer that does not manufacture or produce the Goods it offers to supply shall submit the Manufacturer's Authorization using the form included in Section IV, Tender Forms to demonstrate that it has been duly authorized by the manufacturer or producer of the Goods to supply these Goods in the Purchaser's Country;
- (b) that, if required in the **TDS**, in case of a Tenderer not doing business within the Purchaser's Country, the Tenderer is or will be (if awarded the Contract) represented by an Agent in the country equipped and able to carry out the Supplier's maintenance, repair and spare parts-stocking obligations prescribed in the Conditions of Contract and/or Technical Specifications; and
- (c) that the Tenderer meets each of the qualification criterion specified in Section III, Evaluation and Qualification Criteria.

**18. Period of Validity
of Tenders**

18.1. Tenders shall remain valid for the Tender validity period specified in the **TDS**. The Tender validity period starts from the date fixed for the Tender submission deadline (as prescribed by the Purchaser in accordance with ITT 22). A Tender valid for a shorter period shall be rejected by the Purchaser as nonresponsive.

18.2. In exceptional circumstances, prior to the expiration of the Tender validity period, the Purchaser may request Tenderers to extend the period of validity of their Tenders. The request and the responses

shall be made in writing. If a Tender Security is requested in accordance with ITT 19, it shall also be extended for a corresponding period. A Tenderer may refuse the request without forfeiting its Tender Security. A Tenderer granting the request shall not be required or permitted to modify its Tender, except as provided in ITT 18.3.

- 18.3. If the award is delayed by a period exceeding fifty-six (56) days beyond the expiry of the initial Tender validity period, the Contract price shall be determined as follows:
- (a) In the case of fixed price contracts, the Contract price shall be the Tender price adjusted by the factor specified in the **TDS**.
 - (b) In the case of adjustable price contracts, no adjustment shall be made.
 - (c) In any case, Tender evaluation shall be based on the Tender price without taking into consideration the applicable correction from those indicated above.

19. Tender Security

- 19.1. The Tenderer shall furnish as part of its Tender, either a Tender Security or a Tender-Securing Declaration, as specified in the **TDS**, in original form and, in the case of a Tender Security, in the amount and currency, or in the case of a Tender-Securing Declaration, for the period of ineligibility, as specified in the **TDS**.
- 19.2. A Tender-Securing Declaration shall use the form included in Section IV, Tender Forms.
- 19.3. If a Tender Security is specified pursuant to ITT 19.1, the Tender Security shall be a demand guarantee in any of the following forms at the Tenderer's option:
- (a) an unconditional guarantee issued by a bank,
 - (b) an irrevocable letter of credit,
 - (c) a cashier's or certified check or
 - (d) another security specified in the **TDS**, from a reputable source from an eligible country.

In the case of a bank guarantee, the Tender Security shall be submitted either using the Tender Security Form included in Section IV, Tender Forms, or in another substantially similar format approved by the Purchaser prior to Tender submission. The Tender Security shall be valid for twenty-eight (28) days beyond

the original validity period of the Tender, or beyond any period of extension if requested under ITT 18.2.

- 19.4. If a Tender Security or Tender-Securing Declaration is specified pursuant to ITT 19.1, any Tender not accompanied by a substantially responsive Tender Security or Tender-Securing Declaration shall be rejected by the Purchaser as non-responsive.
- 19.5. If a Tender Security is specified pursuant to ITT 19.1, the Tender Security of unsuccessful Tenderers shall be returned as promptly as possible upon the successful Tenderer's signing the Contract and furnishing the Performance Security pursuant to ITT 46.
- 19.6. The Tender Security of the successful Tenderer shall be returned as promptly as possible once the successful Tenderer has signed the Contract and furnished the required Performance Security.
- 19.7. The Tender Security may be forfeited, or the Tender-Securing Declaration executed:
 - (a) if a Tenderer withdraws its Tender during the period of Tender validity specified by the Tenderer in the Letter of Tender, or any extension thereto provided by the Tenderer; or
 - (b) if the successful Tenderer fails to:
 - (i) sign the Contract in accordance with ITT 45; or
 - (ii) furnish a Performance Security in accordance with ITT 46.
- 19.8. The Tender Security or Tender-Securing Declaration of a JV must be in the name of the JV that submits the Tender. If the JV has not been legally constituted into a legally enforceable JV at the time of tendering, the Tender Security or Tender-Securing Declaration shall be in the names of all future members as named in the letter of intent referred to in ITT 4.1 and ITT 11.2.

20. Format and Signing of Tender

- 20.1 The Tenderer shall prepare one original of the documents comprising the Tender as described in ITT 11 and clearly mark it "ORIGINAL." Alternative Tenders, if permitted in accordance with ITT 13, shall be clearly marked "ALTERNATIVE." In addition, the Tenderer shall submit copies of the Tender, in the number specified in the **TDS** and clearly mark them "COPY." In the event of any discrepancy between the original and the copies, the original shall prevail.
- 20.2 Tenderers shall mark as "CONFIDENTIAL" information in their Tenders which is confidential to their business. This may include

proprietary information, trade secrets or commercial or financially sensitive information.

- 20.3 The original and all copies of the Tender shall be typed or written in indelible ink and shall be signed by a person duly authorized to sign on behalf of the Tenderer. This authorization shall consist of a written confirmation as specified in the **TDS** and shall be attached to the Tender. The name and position held by each person signing the authorization must be typed or printed below the signature. All pages of the Tender where entries or amendments have been made shall be signed or initialed by the person signing the Tender.
- 20.4 In case the Tenderer is a JV, the Tender shall be signed by an authorized representative of the JV on behalf of the JV and so as to be legally binding on all the members as evidenced by a power of attorney signed by their legally authorized representatives.
- 20.5 Any inter-lineation, erasures or overwriting shall be valid only if they are signed or initialed by the person signing the Tender.

D. Submission and Opening of Tenders

21. Sealing and Marking of Tenders

21.1. Tenderers may always submit their Tenders by mail or by hand. If so specified in the **TDS**, tenderers shall have the option of submitting their Tenders electronically. Procedures for submission, sealing and marking are as follows:

- (a) Tenderers submitting Tenders by mail or by hand shall enclose the original and copies of the Tender, including Alternative Tenders if permitted in accordance with ITT 13, in separate sealed envelopes. The envelopes shall be duly marked as "ORIGINAL", "COPY", "ALTERNATIVE-ORIGINAL" and "ALTERNATIVE-COPY". These envelopes shall then be enclosed in one single package. The rest of the procedure shall be in accordance with ITT 21.2 and 21.3.
- (b) Tenderers submitting Tenders electronically shall follow the electronic Tender submission procedures specified in the **TDS**.

21.2. The inner and outer envelopes, shall:

- (a) bear the name and address of the Tenderer,
- (b) be addressed to the Purchaser in accordance with ITT 22.1,
- (c) bear the specific identification of this tendering process indicated in ITT 1.1 and
- (d) bear a warning not to open before the time and date for Tender opening.

21.3 If all envelopes are not sealed and marked as required, the Purchaser will assume no responsibility for the misplacement or premature opening of the Tender.

22. Deadline for Submission of Tenders

22.1. Tenders must be received by the Purchaser at the address and no later than the date and time specified in the **TDS**.

22.2. The Purchaser may, at its discretion, extend the deadline for the submission of Tenders by amending the Tender Document in accordance with ITT 8, in which case all rights and obligations of the Purchaser and Tenderers previously subject to the deadline shall thereafter be subject to the deadline as extended.

23. Late Tenders

23.1. The Purchaser shall not consider any Tender that arrives after the deadline for submission of Tenders, in accordance with ITT 22. Any Tender received by the Purchaser after the deadline for submission of Tenders shall be declared late, rejected and returned unopened to the Tenderer.

24. Withdrawal, Substitution and Modification of Tenders

24.1. A Tenderer may withdraw, substitute or modify its Tender after it has been submitted by sending a written notice, duly signed by an authorized representative, and shall include a copy of the authorization (the power of attorney) in accordance with ITT 20.3 (except that withdrawal notices do not require copies). The corresponding substitution or modification of the Tender must accompany the respective written notice. All notices must be:

- (a) prepared and submitted in accordance with ITT 20 and ITT 21 (except that withdrawal notices do not require copies), and in addition, the respective envelopes shall be clearly marked “WITHDRAWAL,” “SUBSTITUTION” or “MODIFICATION;” and
- (b) received by the Purchaser prior to the deadline prescribed for submission of Tenders, in accordance with ITT 22.

24.2. Tenders requested to be withdrawn in accordance with ITT 24.1 shall be returned unopened to the Tenderers.

24.3. No Tender may be withdrawn, substituted or modified in the interval between the deadline for submission of Tenders and the expiration of the period of Tender validity specified by the Tenderer on the Letter of Tender or any extension thereof.

25. Tender Opening

25.1. Except as in the cases specified in ITT 23 and ITT 24.2, the Purchaser shall, at the Tender opening, publicly open and read out all Tenders received by the deadline at the date, time and place specified in the **TDS** in the presence of Tenderers’ designated representatives and anyone who chooses to attend. Any specific electronic Tender opening procedures required if electronic tendering is permitted in accordance with ITT 21.1, shall be as specified in the **TDS**.

25.2. First, envelopes marked “WITHDRAWAL” shall be opened and read out and the envelope with the corresponding Tender shall not be opened but returned to the Tenderer. No Tender withdrawal shall be permitted unless the corresponding withdrawal notice contains a valid authorization to request the withdrawal and is read out at Tender opening.

25.3. Next, envelopes marked “SUBSTITUTION” shall be opened and read out and exchanged with the corresponding Tender being substituted, and the substituted Tender shall not be opened, but returned to the Tenderer. No Tender substitution shall be permitted unless the corresponding substitution notice contains a valid authorization to request the substitution and is read out at Tender opening.

- 25.4. Next, envelopes marked “MODIFICATION” shall be opened and read out with the corresponding Tender. No Tender modification shall be permitted unless the corresponding modification notice contains a valid authorization to request the modification and is read out at Tender opening.
- 25.5. Next, all remaining envelopes shall be opened one at a time, reading out: the name of the Tenderer and whether there is a modification; the total Tender Price, per lot (contract) if applicable, including any discounts and alternative Tenders; the presence or absence of a Tender Security or Tender-Securing Declaration, if required and any other details as the Purchaser may consider appropriate.
- 25.6. Only Tenders, alternative Tenders and discounts that are opened and read out at Tender opening shall be considered further in the evaluation. The Letter of Tender and the Price Schedules are to be initialed by representatives of the Purchaser attending Tender opening in the manner specified in the **TDS**.
- 25.7. The Purchaser shall neither discuss the merits of any Tender nor reject any Tender (except for late Tenders, in accordance with ITT 23.1).
- 25.8. The Purchaser shall prepare a record of the Tender opening that shall include, as a minimum:
- (a) the name of the Tenderer and whether there is a withdrawal, substitution or modification;
 - (b) the Tender Price, per lot (contract) if applicable, including any discounts;
 - (c) any alternative Tenders and
 - (d) the presence or absence of a Tender Security or Tender-Securing Declaration, if one was required.
- 25.9. The Tenderers’ representatives who are present shall be requested to sign the record. The omission of a Tenderer’s signature on the record shall not invalidate the contents and effect of the record. A copy of the record shall be distributed to all Tenderers who submitted Tenders in time, and posted online when electronic Tendering is permitted.

E. Evaluation and Comparison of Tenders

26. Confidentiality

- 26.1 Information relating to the evaluation of Tenders and recommendation of contract award, shall not be disclosed to Tenderers or any other persons not officially concerned with the Tendering process until the information on Intention to Award the

Contract is transmitted to all Tenderers in accordance with ITT 40.

26.2 Any attempt by a Tenderer to influence the Purchaser in the evaluation or contract award decisions may result in the rejection of its Tender.

26.3 Notwithstanding ITT 26.2, from the time of Tender opening to the time of Contract Award, if any Tenderer wishes to contact the Purchaser on any matter related to the Tendering process, it should do so in writing.

27. Clarification of Tenders

27.1 To assist in the examination, evaluation, comparison of the Tenders and qualification of the Tenderers, the Purchaser may, at its discretion, ask any Tenderer for a clarification of its Tender. Any clarification submitted by a Tenderer in respect to its Tender and that is not in response to a request by the Purchaser shall not be considered. The Purchaser's request for clarification and the response shall be in writing. No change, including any voluntary increase or decrease, in the prices or substance of the Tender shall be sought, offered or permitted, except to confirm the correction of arithmetic errors discovered by the Purchaser in the evaluation of the Tenders, in accordance with ITT 31.

27.2 If a Tenderer does not provide clarifications of its Tender by the date and time set in the Purchaser's request for clarification, its Tender may be rejected.

28. Deviations, Reservations and Omissions

28.1 During the evaluation of Tenders, the following definitions apply:

(a) "Deviation" is a departure from the requirements specified in the Tender Document.

(b) "Reservation" is the setting of limiting conditions or withholding from complete acceptance of the requirements specified in the Tender Document.

(c) "Omission" is the failure to submit part or all of the information or documentation required in the Tender Document.

29. Determination of Responsiveness

29.1 The Purchaser's determination of a Tender's responsiveness is to be based on the contents of the Tender itself, as defined in ITT 11.

29.2 A substantially responsive Tender is one that meets the requirements of the Tender Document without material deviation, reservation or omission. A material deviation, reservation or omission is one that:

(a) if accepted, would:

- (i) affect in any substantial way the scope, quality or performance of the Goods and Related Services specified in the Contract; or
 - (ii) limit in any substantial way, inconsistent with the Tender Document, the Purchaser's rights or the Tenderer's obligations under the Contract; or
- (b) if rectified, would unfairly affect the competitive position of other Tenderers presenting substantially responsive Tenders.

29.3 The Purchaser shall examine the technical aspects of the Tender submitted in accordance with ITT 16 and ITT 17, in particular, to confirm that all requirements of Section VII, Schedule of Requirements, have been met without any material deviation, reservation or omission.

29.4 If a Tender is not substantially responsive to the requirements of Tender Document, it shall be rejected by the Purchaser and may not subsequently be made responsive by correction of the material deviation, reservation or omission.

30. Nonmaterial Nonconformities

30.1 Provided that a Tender is substantially responsive, the Purchaser may waive any nonconformities in the Tender.

30.2 Provided that a Tender is substantially responsive, the Purchaser may request that the Tenderer submit the necessary information or documentation, within a reasonable period of time, to rectify nonmaterial nonconformities or omissions in the Tender related to documentation requirements. Requesting information or documentation on such nonconformities or omissions shall not be related to any aspect of the price of the Tender. Failure of the Tenderer to comply with the request may result in the rejection of its Tender.

30.3 Provided that a Tender is substantially responsive, the Purchaser shall rectify quantifiable nonmaterial nonconformities related to the Tender Price. To this effect, the Tender Price shall be adjusted, for comparison purposes only, to reflect the price of a missing or nonconforming item or component in the manner specified in the **TDS**.

31. Correction of Arithmetical Errors

31.1 Provided that the Tender is substantially responsive, the Purchaser shall correct arithmetical errors on the following basis:

- (a) If there is a discrepancy between the unit price and the line-item total that is obtained by multiplying the unit price and the quantity, the unit price shall prevail and the total price shall be corrected, unless in the opinion of the Purchaser there is an obvious misplacement of the decimal point in the

unit price, in which case the total price as quoted shall govern and the unit price shall be corrected.

- (b) if there is an error in a total corresponding to the addition or subtraction of subtotals, the subtotals shall prevail, and the total shall be corrected.
- (c) If there is a discrepancy between words and figures, the amount in words shall prevail, unless the amount expressed in words is related to an arithmetical error, in which case the amount in figures shall prevail subject to (a) and (b) above.

31.2 Tenderers shall be requested to accept correction of arithmetical errors. Failure to accept the correction in accordance with ITT 31.1, shall result in the rejection of the Tender.

32. Conversion to Single Currency

32.1 For evaluation and comparison purposes, the currencies of the Tender shall be converted into a single currency as specified in the **TDS**.

33. Provisions for Development of Domestic Industry

33.1 Unless otherwise specified in the **TDS**, provisions for development of domestic industry shall not apply.

34. Evaluation of Tenders

34.1 The Purchaser shall use the criteria and methodologies listed in this ITT and Section III, Evaluation and Qualification criteria. No other evaluation criteria or methodologies shall be permitted. By applying the criteria and methodologies, the Purchaser shall determine the Most Advantageous Tender in accordance with ITT 41.

34.2 To evaluate a Tender, the Purchaser shall consider the following:

- (a) evaluation will be done for Items or Lots (contracts), as specified in the **TDS**; and the Tender Price as quoted in accordance with ITT 14;
- (b) price adjustment for correction of arithmetical errors in accordance with ITT 31.1;
- (c) price adjustment due to discounts offered in accordance with ITT 14.4;
- (d) price adjustment due to quantifiable nonmaterial nonconformities in accordance with ITT 30.3;
- (e) price adjustment due to application of the additional evaluation factors specified in Section III, Evaluation and Qualification Criteria; and

- (f) converting the amount resulting from applying (a) to (e) above, if relevant, to a single currency in accordance with ITT 32;
- 34.3 The estimated effect of the price adjustment provisions of the Conditions of Contract, applied over the period of execution of the Contract, shall not be taken into account in tender evaluation.
- 34.4 If the Tender Document allows Tenderers to quote separate prices for different lots (contracts), the methodology to determine the lowest evaluated cost of the lot (contract) combinations, including any discounts offered in the Letter of Tender, is specified in Section III, Evaluation and Qualification Criteria.
- 34.5 The Purchaser's evaluation of a Tender will exclude, and not take into account:
- (a) In the case of Goods manufactured in the Purchaser's Country, all sales and other similar taxes, applicable in the Purchaser's Country and payable on the goods if a contract is awarded to the Tenderer.
 - (b) In the case of Goods manufactured outside the Purchaser's Country, already imported or to be imported, all customs duties and other import taxes levied on the imported Goods, sales and other similar taxes, applicable in the Purchaser's Country and payable on the Goods if the contract is awarded to the Tenderer.
 - (c) Any allowance for price adjustment during the period of execution of the contract, if provided in the Tender.
- 34.6 The Purchaser's evaluation of a Tender may require the consideration of other factors, in addition to the Tender Price quoted in accordance with ITT 14. These factors may be related to the characteristics, performance and terms and conditions of purchase of the Goods and Related Services. The effect of the factors selected, if any, shall be expressed in monetary terms to facilitate comparison of Tenders, unless otherwise specified in the **TDS** from among those set out in Section III, Evaluation and Qualification Criteria. The criteria and methodologies to be used shall be as specified in ITT 34.2(e).

35. Comparison of Tenders

- 35.1 The Purchaser shall compare the evaluated costs of all substantially responsive Tenders established in accordance with ITT 34.2 to determine the Tender that has the lowest evaluated cost. The comparison shall be on the basis of CIP (place of final destination) prices for imported goods and EXW prices, plus cost of inland transportation and insurance to place of final destination, for goods manufactured within the Purchaser's country, together with prices for any required installation, training, commissioning

and other services. The evaluation of prices shall not take into account custom duties and other taxes levied on imported goods quoted CIP and sales and similar taxes levied in connection with the sale or delivery of goods.

**36. Abnormally Low-
Priced Tenders**

36.1 An Abnormally Low-Priced Tender is one where the Tender price, in combination with other constituent elements of the Tender, appears unreasonably low to the extent that it raises material concerns with the Purchaser as to the capability of the Tenderer to perform the Contract for the offered Tender price.

36.2 In the event of identification of a potentially Abnormally Low-Priced Tender, the Purchaser shall seek written clarifications from the Tenderer, including a detailed price analyses of its Tender price in relation to the subject matter of the contract, scope, delivery schedule, allocation of risks and responsibilities and any other requirements of the Tender Document.

36.3 After examining the clarifications given and the detailed price analyses presented by the Tenderer, the Purchaser may:

- (a) accept the Tender, if the evidence provided satisfactorily accounts for the low price and costs, in which case the Tender is not considered abnormally low;
- (b) accept the Tender but require that the amount of the Performance Security be increased at the expense of the Tenderer to a level sufficient to protect the Purchaser against financial loss in the event of default of the successful Tenderer under the contract. The amount of the Performance Security shall generally not be more than 20 percent of the Contract Price; or
- (c) reject the Tender if the evidence provided does not satisfactorily account for the low tender price, and make a similar determination for the next lowest evaluated Tender, if required.

**37. Post-
Qualification of
the Tenderer**

37.1 The Purchaser shall determine, to its satisfaction, whether the Tenderer that is selected as having submitted the lowest evaluated cost and substantially responsive Tender, meets the qualifying criteria specified in Section III, Evaluation and Qualification Criteria.

37.2 The determination shall be based upon an examination of the documentary evidence of the Tenderer's qualifications submitted by the Tenderer, pursuant to ITT 17. The determination shall not take into consideration the qualifications of other firms such as the Tenderer's subsidiaries, parent entities, affiliates, subcontractors (other than specialized subcontractors if permitted

in the Tender Document), or any other firm(s) different from the Tenderer.

- 37.3 An affirmative determination shall be a prerequisite for award of the Contract to the Tenderer. A negative determination shall result in disqualification of the Tender, in which event the Purchaser shall proceed to the Tenderer who offers a substantially responsive Tender with the next lowest evaluated cost to make a similar determination of that Tenderer's qualifications to perform satisfactorily.
- 38. Purchaser's Right to Accept Any Tender, and to Reject Any or All Tenders** 38.1 The Purchaser reserves the right to accept or reject any Tender, and to annul the tender process and reject all Tenders at any time prior to Contract Award, without thereby incurring any liability to Tenderers. In case of annulment, all Tenders submitted and specifically, tender securities, shall be promptly returned to the Tenderers.
- 39. Standstill Period** 39.1 The Contract shall not be awarded earlier than the expiry of the Standstill Period. The Standstill Period shall be ten (10) Business Days unless extended in accordance with ITT 44. The Standstill Period commences the day after the date the Purchaser has transmitted to each Tenderer the Notification of Intention to Award the Contract. Where only one Tender is submitted, or if this contract is in response to an emergency situation recognized by the Bank, the Standstill Period shall not apply.
- 40. Notification of Intention to Award** 40.1 The Purchaser shall send to each Tenderer the Notification of Intention to Award the Contract to the successful Tenderer. The Notification of Intention to Award shall contain, at a minimum, the following information:
- (a) the name and address of the Tenderer submitting the successful Tender;
 - (b) the Contract price of the successful Tender;
 - (c) the names of all Tenderers who submitted Tenders, and their tender prices as readout, and as evaluated;
 - (d) a statement of the reason(s) the Tender (of the unsuccessful Tenderer to whom the notification is addressed) was unsuccessful, unless the price information in (c) above already reveals the reason;
 - (e) the expiry date of the Standstill Period; and
 - (f) instructions on how to request a debriefing and/or submit a complaint during the standstill period.

F. Award of Contract

- 41. Award Criteria**
- 41.1 Subject to ITT 38, the Purchaser shall award the Contract to the Tenderer offering the Most Advantageous Tender. The Most Advantageous Tender is the Tender of the Tenderer that meets the qualification criteria and whose Tender has been determined to be:
- (a) substantially responsive to the Tender Document; and
 - (b) the lowest evaluated cost tender that provides Value-for-Money.
- 42. Purchaser’s Right to Vary Quantities at Time of Award**
- 42.1 At the time the Contract is awarded, the Purchaser reserves the right to increase or decrease the quantity of Goods and Related Services originally specified in Section VII, Schedule of Requirements, provided this does not exceed the percentages specified in the **TDS**, and without any change in the unit prices or other terms and conditions of the Tender and the Tender Document.
- 43. Notification of Award**
- 43.1 Prior to the expiration of the Tender Validity Period and upon expiry of the Standstill Period, specified in ITT39.1 or any extension thereof, and upon satisfactorily addressing any complaint that has been filed within the Standstill Period, the Purchaser shall notify the successful Tenderer, in writing, that its Tender has been accepted. The notification of award (hereinafter and in the Contract Forms called the “Letter of Acceptance”) shall specify the sum that the Purchaser will pay the Supplier in consideration of the execution of the Contract (hereinafter and in the Conditions of Contract and Contract Forms called “the Contract Price”).
- 43.2 Within ten (10) Business Days after the date of transmission of the Letter of Acceptance, the Purchaser shall publish the Contract Award Notice which shall contain, at a minimum, the following information:
- (a) name and address of the Purchaser;
 - (b) name and reference number of the contract being awarded, and the procurement method used;
 - (c) names of all Tenderers that submitted Tenders, and their tender prices as read out at tender opening, and as evaluated;
 - (d) names of all Tenderers whose Tenders were rejected either as nonresponsive or as not meeting qualification criteria, or were not evaluated, with the reasons therefor;
 - (e) the name of the successful Tenderer, the final total contract price, the contract duration and a summary of its scope and

- (f) successful Tenderer's Beneficial Ownership Disclosure Form, if specified in TDS ITT 45.1.

- 43.3 The Contract Award Notice shall be published on the Purchaser's website with free access if available, or in at least one newspaper of national circulation in the Purchaser's Country, or in the official gazette. The Purchaser shall also publish the contract award notice in United Nations Development Business online and AIIB's website.
- 43.4 Until a formal Contract is prepared and executed, the Letter of Acceptance shall constitute a binding Contract.

44. Debriefing by the Purchaser

- 44.1 On receipt of the Purchaser's Notification of Intention to Award referred to in ITT 40.1, an unsuccessful Tenderer has three (3) Business Days to make a written request to the Purchaser for a debriefing. The Purchaser shall provide a debriefing to all unsuccessful Tenderers whose request is received within this deadline.
- 44.2 Where a request for debriefing is received within the deadline, the Purchaser shall provide a debriefing within five (5) Business Days, unless the Purchaser decides, for justifiable reasons, to provide the debriefing outside this timeframe. In that case, the standstill period shall automatically be extended until five (5) Business Days after such debriefing is provided. If more than one debriefing is so delayed, the standstill period shall not end earlier than five (5) Business Days after the last debriefing takes place. The Purchaser shall promptly inform, by the quickest means available, all Tenderers of the extended standstill period
- 44.3 Where a request for debriefing is received by the Purchaser later than the three (3)-Business Day deadline, the Purchaser should provide the debriefing as soon as practicable, and normally no later than fifteen (15) Business Days from the date of publication of the Contract Award Notice. Requests for debriefing received outside the three (3)-day deadline shall not lead to extension of the standstill period.
- 44.4 Debriefings of unsuccessful Tenderers may be done in writing or verbally. The Tenderers shall bear their own costs of attending such a debriefing meeting.

45. Signing of Contract

- 45.1 The Purchaser shall send to the successful Tenderer the Letter of Acceptance including the Contract Agreement, and, if specified in the TDS, a request to submit the Beneficial Ownership Disclosure Form providing additional information on its beneficial ownership. The Beneficial Ownership Disclosure

Form, if so requested, shall be submitted within eight (8) Business Days of receiving this request.

45.2 The successful Tenderer shall sign, date and return to the Purchaser, the Contract Agreement within twenty-eight (28) days of its receipt.

45.3 Notwithstanding ITT 45.2 above, in case signing of the Contract Agreement is prevented by any export restrictions attributable to the Purchaser, to the country of the Purchaser, or to the use of the products/goods, systems or services to be supplied, where such export restrictions arise from trade regulations from a country supplying those products/goods, systems or services, the Tenderer shall not be bound by its Tender, always provided however, that the Tenderer can demonstrate to the satisfaction of the Purchaser and of the Bank that signing of the Contract Agreement has not been prevented by any lack of diligence on the part of the Tenderer in completing any formalities, including applying for permits, authorizations and licenses necessary for the export of the products/goods, systems or services under the terms of the Contract.

**46. Performance
Security**

46.1 Within twenty-eight (28) days of the receipt of Letter of Acceptance from the Purchaser, the successful Tenderer, if required, shall furnish the Performance Security in accordance with the GCC 18, using for that purpose the Performance Security Form included in Section X, Contract Forms or another Form acceptable to the Purchaser.

46.2 Failure of the successful Tenderer to submit the above-mentioned Performance Security or sign the Contract shall constitute sufficient grounds for the annulment of the award and forfeiture of the Tender Security. In that event the Purchaser may award the Contract to the Tenderer offering the next Most Advantageous Tender.

**47. Procurement-
Related Complaint**

47.1 The procedures for making a Procurement-Related Complaint are as specified in the **TDS**.

Section II - Tender Data Sheet (TDS)

The following specific data for the goods to be procured shall complement, supplement or amend the provisions in the Instructions to Tenderers (ITT). Whenever there is a conflict, the provisions herein shall prevail over those in ITT.

ITT Reference	A. General
ITT 1.1	<p>The reference number of the SPN/Tender is: HORC/HRIDC/PSC 01/2023</p> <p>The Purchaser is: Haryana Orbital Rail Corridor Limited (HORCL)</p> <p>The name of the Tender is: PSC-01: Manufacture and Supply of Pre-stressed Mono Block Concrete Line Sleepers conforming to RDSO Drg. No. T-8746 in connection with laying of New BG Double Railway Line from Prithla to New Harsana Kalan of Haryana Orbital Rail Corridor (HORC) Project.</p> <p>The number and identification of this Tender is: HORC/HRIDC/PSC-01/2023</p>
ITT 1.2(a)	<p>Electronic Procurement System</p> <p>The Purchaser shall use the following electronic procurement system to manage this Tendering process:</p> <p>E-procurement portal of Govt. of Haryana (https://etenders.hry.nic.in)</p>
ITT 2.1	<p>The Recipient is: Haryana Orbital Rail Corporation Limited (HORCL) through Government of Haryana</p> <p>The Bank Loan No.: Under Process; Loan Amount–USD 272 million</p> <p>The name of the Project is: Haryana Orbital Rail Corridor (HORC)</p>
ITT 4.1	Joint venture is not permitted to take part in above Tender.
ITT 4.5	<p>A list of debarred firms and individuals is available on the Bank’s external website: https://www.aiib.org/debarment/</p>
ITT 6.3	<p>Replace ITT 6.3 with the following:</p> <p>The complete Tender Document can be viewed/ downloaded by the Tenderer from eProcurement portal of Govt. of Haryana https://etenders.hry.nic.in. The Purchaser is not responsible for the completeness of the Tender Document and their addenda, if they were not obtained directly from eProcurement portal of Govt. of Haryana https://etenders.hry.nic.in.</p>
	B. Contents of Tender Document

<p>ITT 7.1</p>	<p>Replace the entire Sub-Clause 7.1 with the following:</p> <p>For <u>Clarification of Tender purposes</u>, A Pre-Tender Meeting will take place through online Video conferencing (VC) as well as offline in the Conference room of HRIDC office, Plot No 143, Railtel Tower, Sector-44, Gurugram, Haryana-122003 at the following date and time:</p> <p>Date: 19.10.2023 Time: 11.00 hrs. IST</p> <p>The purpose of the meeting will be to clarify issues and to answer questions on any matter that may be raised at that stage. The prospective Tenderers who wish to join the Pre-Tender Meeting through VC shall send a request (giving details of the Company, its address, and the name, designation and email of the person attending the VC) through email along with an editable soft copy (MS Word) of the queries raised by them on the email id (i.e.horc.etendering@gmail.com) so that a link for Video Conferencing can be sent by HRIDC. The Tenderers should use the following format for any Pre-Tender queries</p> <p>For <u>Clarification of Tender purposes</u> only, the Purchaser's address is:</p> <p>Attention: GM (IP&IT)</p> <p>Street address: Haryana Rail Infrastructure Development Corporation Limited (HRIDC), Plot no.143, Railtel Tower, Sector-44</p> <p>Floor: 5th floor</p> <p>City: Gurugram</p> <p>ZIP code: 122003</p> <p>Country: India</p> <p>Telephone: +91 7011056770</p> <p>E-mail: horc.etendering@gmail.com</p> <p>The prospective Tenderers should send their Pre-Tender Queries through email along with an editable soft copy (MS Word) of the queries raised by them on the email id (i.e.horc.etendering@gmail.com). The Tenderers should use the following format for any Pre-Tender queries:</p> <table border="1" data-bbox="483 1682 1430 1858"> <thead> <tr> <th data-bbox="483 1682 609 1759">Query No.</th> <th data-bbox="609 1682 885 1858">Reference to Tender Document (Clause/ Para No. & Page No.)</th> <th data-bbox="885 1682 1193 1759">Brief Description of Clause/ Para No.</th> <th data-bbox="1193 1682 1430 1759">Query Raised</th> </tr> </thead> <tbody> <tr> <td> </td> <td> </td> <td> </td> <td> </td> </tr> </tbody> </table>			Query No.	Reference to Tender Document (Clause/ Para No. & Page No.)	Brief Description of Clause/ Para No.	Query Raised				
Query No.	Reference to Tender Document (Clause/ Para No. & Page No.)	Brief Description of Clause/ Para No.	Query Raised								

	<table border="1"> <tr><td>1.</td><td></td><td></td><td></td></tr> <tr><td>2.</td><td></td><td></td><td></td></tr> <tr><td>3.</td><td></td><td></td><td></td></tr> <tr><td>4.</td><td></td><td></td><td></td></tr> <tr><td>etc.</td><td></td><td></td><td></td></tr> </table> <p>HRIDC will allow maximum of one email Id for one company to participate in the VC. Any request for VC received after the given date and time for sending the link for VC may not be entertained by HRIDC. Prospective Tenderers will be able to join the VC through the link provided to them on their Email ID.</p>	1.				2.				3.				4.				etc.			
1.																					
2.																					
3.																					
4.																					
etc.																					
	C. Preparation of Tenders																				
ITT 10.1	<p>The language of the Tender is: <i>English</i></p> <p>All correspondence exchange shall be in English language.</p>																				
ITT 11.1	<p>Replace ITT 11.1 with the following:</p> <p>11.1.1 The Tenderer shall submit their Tender online on eProcurement portal https://etenders.hry.nic.in as mentioned in para ITT 21.</p> <p>The Tender shall comprise two parts submitted simultaneously, one called the Technical Part containing the documents listed in ITT 11.1.2 and the other the Financial Part containing the documents listed in ITT 11.1.3.</p> <p>The Tenderer shall upload only the above mentioned documents in its submission on eProcurement portal. Tenderer is not required to upload Part 1, Part 2 and Part 3 of the Tender document issued by the Purchaser. The master copy of Tender Document published on eProcurement portal shall be available with HRIDC which shall be final and binding.</p> <p>11.1.2 The Tenderer shall submit all the documents in its Technical Part as per the Checklist CL (A. Technical Part) given in Section III: Evaluation and Qualification Criteria.</p> <p>11.1.3 The Tenderer shall submit all the documents in its Financial Part as per the Checklist CL (B. Financial Part) given in Section III: Evaluation and Qualification Criteria</p>																				
ITT 11.2	Deleted																				

ITT 13.1	Alternative Tenders shall not be considered.
ITT 14.2	Replace ITT 14.2 with the following: - The Tenderer shall quote single percentage (%) Excess (+) or Less (-) on the estimated amount for Schedule 'A' in the prescribed place of Price Schedule in MS-Excel file.
ITT 14.4	Replace ITT 14.4 with the following: - As there is no lot in this Contract Package, no discounts shall be quoted by the Tenderers.
ITT 14.5	The prices quoted by the Tenderer <i>shall</i> be subject to adjustment during the performance of the Contract as per pre-defined price adjustment formula detailed in Sub-Clause 15.1 of Section IX- Special Conditions of Contract (SCC).
ITT 14.7	The Incoterms edition is: 2020 latest updated.
ITT 14.8	Replace ITT 14.8 with the following: 14.8 Prices shall be quoted as specified in Price Schedule included in Section IV, Tender Forms. In quoting prices, the Tenderer shall be free to use transportation through carriers registered in any eligible country, in accordance with Section V, Eligible Countries. Similarly, the Tenderer may obtain insurance services from any eligible country in accordance with Section V, Eligible Countries. The quoted price shall be inclusive of the following: (a) For Goods manufactured in the Purchaser's Country: (i) the price of the Goods quoted EXW (ex-works, ex-factory, ex-warehouse, ex-showroom or off-the-shelf, as applicable), including all customs duties and sales and other taxes already paid or payable on the components and raw material used in the manufacture or assembly of the Goods; (ii) any Purchaser's Country sales tax and other taxes which will be payable on the Goods if the Contract is awarded to the Tenderer; and (iii) the price for inland transportation, insurance and other local services required to convey the Goods to their final destination (Project Site) specified in the TDS. (b) For Goods manufactured outside the Purchaser's Country, to be imported: (i) the price of the Goods, quoted CIP named place of destination, in the Purchaser's Country, as specified in the TDS; and (ii) the price for inland transportation, insurance and other local services required to convey the Goods from the named place of destination to their final destination (Project Site) specified in the TDS. (c) For Goods manufactured outside the Purchaser's Country, already imported: (i) the price of the Goods, including the original import value of the Goods; plus any mark-up (or rebate); plus any other related local cost,

	<p>and custom duties and other import taxes already paid or to be paid on the Goods already imported;</p> <p>(ii) the custom duties and other import taxes already paid (need to be supported with documentary evidence) or to be paid on the Goods already imported;</p> <p>(iii) the price of the Goods, obtained as the difference between (i) and (ii) above;</p> <p>(iv) any Purchaser's Country sales and other taxes which will be payable on the Goods if the Contract is awarded to the Tenderer; and</p> <p>(v) the price for inland transportation, insurance and other local services required to convey the Goods from the named place of destination to their final destination (Project Site) specified in the TDS.</p> <p>(d) For Related Services, other than inland transportation and other services required to convey the Goods to their final destination, whenever such Related Services are specified in the Schedule of Requirements, the price of each item comprising the Related Services (inclusive of any applicable taxes).</p>
ITT 15.1	The currency of the Tender shall be in Indian Rupees (INR) only. The Tender price shall be quoted in INR only.
ITT 16.4	<i>Not Applicable</i>
ITT 17.2 (b)	After sales services is not required
ITT 18.1	The Tender validity period shall be 180 days after the Tender submission deadline date.
ITT 19.1	The Tenderer shall furnish a Tender Security for an amount of INR 5,000,000.00 (INR Five Million only) .
ITT 19.2	Not Applicable
ITT 19.3	<p>Replace the ITT 19.3 with the following:</p> <p>The amount for Tender Security specified in ITT 19.1 above can be paid online by eligible Tenderers on eProcurement Portal in INR in favour of Haryana Rail Infrastructure Development Corporation Limited using the electronic payment gateway service or Tender Security can be submitted in the form of unconditional and irrevocable Bank Guarantee in INR or the equivalent amount in a freely convertible currency from the specified banks using the Tender Security Form included in Section IV, Tender Forms. The Bank Guarantee shall be issued from:</p> <p>(i) a scheduled bank (excluding co-operative banks) in India, or</p> <p>(ii) a Foreign Bank having arrangement with a nationalized bank or scheduled banks (excluding co-operative banks) in India;</p>

The scheduled bank issuing the bank guarantee shall be on “Structure Financial Messaging System (SFMS)” platform. A separate advice of the Bank Guarantee shall invariably be sent by the issuing bank to the Purchaser’s Bank through SFMS and only after receipt of the same by the Purchaser’s Bank, the bank guarantee shall become operative and acceptable to the Purchaser. Further, the bank guarantee in original form along with a copy of “MT760COV (in case of bank guarantee message)/ MT767COV (in case of bank guarantee amendment message) Report” sent by the concerned issuing bank sealed in an envelope shall be submitted to the Purchaser within ten (10) days of deadline of submission of Tender.

The Issuing Bank shall send the SFMS to:

Beneficiary: Haryana Rail Infrastructure Development Corporation Limited

Bank Name: State Bank of India

Account Number: 38848977231

Branch: SME Branch, Sector 8, Chandigarh

IFSC Code: SBIN0011705

The Tender Security shall be valid for twenty-eight (28) days beyond the original validity period of the Tender, or beyond any period of extension if requested under ITT 18.2.

In case the Tenderer has opted for Tender Security in the form of an unconditional Bank guarantee, the Tenderer shall upload the scanned copy of Bank Guarantee with the Tender. The original Bank Guarantee shall be delivered either by Registered Post/Speed Post/Courier or by hand within ten (10) days of deadline of submission of Tender at the address given below:

General Manager/IP & IT
Haryana Rail Infrastructure Development Corporation Limited,
Plot No 143, 5th Floor, Railtel Tower,
Sector-44, Gurugram,
Haryana-122003

Non submission of scanned copy of Bank Guarantee with the Tender on eProcurement portal and/or no submission of original Bank Guarantee within the specified period shall lead to summary rejection of Tender. The details of the Original Bank Guarantee should match with the details

	<p>available in the scanned copy and the data entered during Tender submission time, failing which the Tender shall be rejected.</p> <p>Notes:</p> <ol style="list-style-type: none"> 1. In case SFMS for the Bank Guarantee is not received by the Purchaser's Bank through SFMS, original copy of BG received in such a manner will be sent to the concerned Bank for its verification and only after its confirmation from the Bank, BG shall be acceptable by the Purchaser and Tender shall be evaluated . 2. Option of Exemption from payment of EMD mentioned in the module of eProcurement portal is only for exemption of online payment of Tender Security to the Tenderers who wish to submit Tender Security in the form of Bank Guarantee.
<p>ITT 20.1</p>	<p>Replace ITT 20.1 with the following:</p> <p>The Technical Part (comprising of documents specified in ITT 11.1.2 above) and Financial Part (comprising of documents specified in ITT 11.1.3 above) shall be submitted online on eProcurement portal of Government of Haryana (https://etenders.hry.nic.in) only in accordance with the requirements of the Tender Document.</p>
<p>ITT 20.3</p>	<p>The written confirmation of authorization to sign on behalf of the Tenderer shall consist of:</p> <ol style="list-style-type: none"> (a) In case of Private/Public Companies, a Power of Attorney from the Director of the Company who has been authorized by the Board of Directors through resolution to sign on behalf of the Company. Copy of Board Resolution shall also be submitted. In case of Foreign Members, Power of Attorney(s) and Board Resolution confirming authority on the persons issuing the Power of Attorney for such actions shall be submitted duly translated by licensed translator and duly notarized by the notary public of country of origin. (b) Where the Successful Tenderer is a Foreign Entity , such Foreign entity shall be required to submit all the documents either duly stamped by Indian Embassy/High Commission or Member Countries of Hague convention may submit these document with “Apostille” stamp before signing the Contract.(b) In case of Proprietary Tenderers, Power of Attorney by the Proprietor.

	<p>(c) In case of Partnership firms, Power of Attorney duly signed by all the Partners.</p> <p>(d) In case of Limited Liability Partnership (LLP) firms, a Power of Attorney issued by the LLP in favour of the individual to sign the tender on behalf of the LLP and create liability against the LLP.</p> <p>(e) The mode of execution of the Power of Attorney should be in accordance with the procedure, if any, laid down by the applicable law and the charter documents of the executant(s) and when it is so required the same should be under common seal affixed in accordance with the required procedure.</p>
ITT 20.4	Deleted
	D. Submission and Opening of Tenders
ITT 21	<p>Replace ITT 21 with the following:</p> <p>21.1 Tenderers shall upload their tender submission online on eProcurement portal (i.e. https://etenders.hry.nic.in) within the stipulated date and time as mentioned in ITT 22.1. The Tenderer shall ensure that they retain a copy of the receipt/ acknowledgement of their Tender submission which is generated by the system upon successful submission of Tender online.</p> <p>21.2 Tenders sent telegraphically or through any other means of transmission except as mentioned above shall be treated as invalid and shall stand rejected.</p> <p>21.3 No details about Financial Part shall be submitted/ disclosed directly or indirectly in the Technical Part failing which the Purchaser has the right to reject the Tender.</p> <p>21.4 Instructions for Online Tender Submission</p> <p>The Tenderers are required to submit soft copies of their Tenders electronically on the eProcurement portal of Government of Haryana i.e. https://etenders.hry.nic.in, using valid Digital Signature Certificates. The instructions given below are meant to assist the Tenderers in registering on the eProcurement Portal, prepare their Tenders in accordance with the requirements and submitting their Tenders online on the eProcurement Portal.</p> <p>Registration:</p>

	<p>i) Tenderers are required to enroll on the above-mentioned eProcurement portal by clicking on the link “Online Bidder Enrollment” on the Portal which is free of charge.</p> <p>ii) As part of the enrolment process, the Tenderers will be required to choose a unique username and assign a password for their accounts.</p> <p>iii) Tenderers are advised to register their valid email address and mobile numbers as part of the registration process. These would be used for any communication from the eProcurement Portal.</p> <p>A. Obtaining a Digital Certificate:</p> <p>i. The Tenders submitted online should be encrypted and signed electronically with a Digital Certificate to establish the identity of the Tenderer online. These Digital Certificates are issued by an Approved Certifying Authority, by the Controller of Certifying Authorities, Government of India.</p> <p>ii. A Digital Certificate is issued upon receipt of mandatory identity (i.e. Applicant’s PAN Card) and Address proofs and verification form duly attested by the Bank Manager / Postmaster / Gazetted Officer. Only upon the receipt of the required documents, a digital certificate can be issued. For more details please visit the website – https://etenders.hry.nic.in</p> <p>iii. The Tenderers may obtain Class-II or III digital signature certificate from any Certifying Authority or Sub-certifying Authority authorized by the Controller of Certifying Authorities or may obtain information, application format and documents required for the issue of digital certificate.</p> <p>iv. The Tenderer must ensure that he/she comply by the online available important guidelines at the portal https://etenders.hry.nic.in for Digital Signature Certificate (DSC) including the e-Token carrying DSCs.</p> <p>For any queries related to e-tendering process (registration, online e-bid submission/withdrawal, uploading of documents), Tenderer may contact the below representative of NIC:</p> <p>Mr. Anuj Mahajan E - mail: amahajan@nic.in, eprocnic hry@yahoo.com Help Desk: 0120-4001002, 0120-4200462, 0120-4001005, 0120-6277787, 0172-2700275.</p>
--	--

	<p>v. Tender for a particular tender must be submitted online using the digital certificate (Encryption & Signing), which is used to encrypt and sign the data during the stage of Tender preparation. In case, during the process of a particular tender, the user loses his digital certificate (due to virus attack, hardware problem, operating system or any other problem) he will not be able to submit the Tender online.</p> <p>Hence, the users are advised to keep a backup of the certificate and also keep the copies at safe place under proper security (for its use in case of emergencies).</p> <p>vi. In case of online tendering, if the digital certificate issued to the authorized user of a firm is used for signing and submitting a Tender, it will be considered equivalent to a no-objection certificate/power of attorney/lawful authorization to that User only for accessing eProcurement portal for online Tender submission on the portal. The firm has to authorize a specific individual through an authorization certificate signed by all partners to use the digital certificate as per Indian Information Technology Act 2000. Unless the certificates are revoked, it will be assumed to represent adequate authority of the user to Tender on behalf of the firm in the department tenders as per Information Technology Act 2000. The digital signature of this authorized user will be binding on the firm. This shall in no way relieve the Tenderer from the requirement of submission of Power of Attorney by the Tenderer in terms of ITT 20.3 and ITT 20.4 of Tender Document.</p> <p>vii. In case of any change in the authorization, it shall be the responsibility of management/ partners of the firm to inform the certifying authority about the change and to obtain the digital signatures of the new person/ user on behalf of the firm/ company. The procedure for application of a digital certificate however will remain the same for the new user.</p> <p>viii. The same procedure holds true for the authorized users in a private/Public limited company. In this case, the authorization certificate will have to be signed by the directors of the company.</p> <p>B. Opening of an Electronic Payment Account: (Purchase of Tender Document - Online)</p> <p>For purchasing the Tender Document online, Tenderers are required to pay the Tender Document fee online using the electronic payment gateway service through their Debit Cards & Internet Banking</p>
--	--

accounts. For online payments guidelines, please refer to the Home page under tab “**Guidelines for hassle free Bid Submission**” of the eProcurement Portal of Government of Haryana, <https://etenders.hry.nic.in>

C. Pre-requisites for online Tendering:

In order to operate on the electronic tender management system, a user’s machine is required to be set up. A help file on system setup/Pre-requisite can be obtained from National Informatics Center or downloaded from the home page of the website - <https://etenders.hry.nic.in> the link for downloading required java applet & DC setup are also available on the Home page of the eProcurement Portal.

D. Online Viewing of Specific Procurement Notice (SPN):

The Tenderers can view the SPN and the time schedule (Key Dates) through the single portal eProcurement system on the Home Page at <https://etenders.hry.nic.in>

E. Downloading of Tender Documents:

The detailed Tender Document can be downloaded free of cost from the eProcurement portal <https://etenders.hry.nic.in> from **10.10.2023 (17:00 Hrs. IST) to 22.11.2023 (15:00 Hrs. IST.)**

F. Key Dates:

The Tenderers are strictly advised to follow dates and times as indicated in the online Specific Procurement Notice. The date and time shall be binding on all Tenderers. All online activities are time tracked and the system enforces time locks that ensure that no activity or transaction can take place outside the start and end dates and the time of the stage as defined in the online Specific Procurement Notice.

G. Online Payment of E-Service Fee & Tender Security:

The online payment for E-Service Fee and Tender Security in INR shall be made using the secure electronic payment gateway by Tenderers online directly through Debit Cards & Internet Banking accounts.

The secure electronic payments gateway is an online interface between Suppliers/Contractors and Debit card/online payment authorization networks.

H. Offline Payment of Tender Security

For submission of the Tender Security in the form of BG (Tender Security offline Payment), System will direct Tenderer to the EMD details page (EMD Payment offline). Following Steps are to be followed:

Step 1: Select ‘Yes’ option where system asks “Are you submitting EMD through BG/ST or Exempted from EMD payment”.

Step2: Select ‘Percentage’ option to choose EMD exemption type and insert 100% as exemption.

Step 3: Tenderer must upload scanned copy of Bank Guarantee as EMD exemption document on eProcurement Portal. After uploading the document, Tenderer must sign the document digitally.

Step 4: After confirming the details of payment, Tenderer must Select option "Confirm to pay"

Step 5: Tenderer must enter the details of BG as EMD fee detail on EMD offline payment page

Note: Option of Exemption from payment of EMD mentioned in the module of eProcurement portal is only for exemption of online payment of Tender Security to the Tenderers who wish to submit Tender Security in the form of Bank Guarantee.

I. Preparation & Submission of online Applications/Tenders:

i. Tender shall mandatorily be submitted online following the instruction appearing on the screen.

ii. **Scan copy of Documents to be submitted/uploaded for Technical Part under online PQQ/ Technical Envelope:**

All documents shall be prepared and scanned in file formats PDF /JPEG/MS WORD format such that file size does not exceed 10 MB) and uploaded during the online submission of PQQ or Technical Envelope.

iii. **FINANCIAL PART (MS-Excel File for quoting price and Pdf file for Letter of Tender-Financial Part and Appendix A to Letter of Tender- Financial Part) shall be submitted mandatorily online under Commercial Envelope and original not to be submitted manually.**

	<p>NOTES:</p> <p><i>(A) Tenderers participating in online tenders shall check the validity of his/her Digital Signature Certificate before participating in the online Tenders at the portal https://etenders.hry.nic.in.</i></p> <p><i>For help manual, please refer to the ‘Home Page’ of the eProcurement website at https://etenders.hry.nic.in.</i></p>
<p>ITT 22.1</p>	<p>Replace ITT 22.1 with the following:</p> <p>The Tender submission is through the eProcurement portal only (i.e. https://etenders.hry.nic.in) as specified in ITT 21.1</p> <p>The Tenderer shall submit its Tender before expiry of the date and time for tender submission as specified herein.</p> <p>The start date for Tender submission is:</p> <p>Date: 15.11.2023</p> <p>Time: 1100 hrs. IST</p> <p>The deadline for Tender submission is:</p> <p>Date: 22.11.2023</p> <p>Time: 1500 hrs. IST</p>
<p>ITT 23.1</p>	<p>Replace ITT 23.1 with the following:</p> <p>Submission of Tenders shall be closed on eProcurement portal on the date & time of submission as prescribed in ITT 22.1 after which no tender can be uploaded.</p>
<p>ITT 24</p>	<p>Replace ITT 24 with the following:</p> <p>24.1 The Tenderer may modify, substitute or withdraw its e-Tender after submission prior to the deadline for submission of Tenders. For modification of e-Tender, Tenderer has to detach its old Tender from eProcurement portal (https://etenders.hry.nic.in) and upload/ resubmit digitally signed modified tender. For withdrawal of tender, Tenderer has to click on withdrawal icon at e- procurement portal and can withdraw its e-tender. Before withdrawal of a tender, it may specifically be noted that after withdrawal of a tender for any reason, Tenderer cannot re-submit e-tender again.</p>

	<p>24.2 No Tender may be withdrawn, substituted, or modified in the interval between the deadline for submission of Tenders and the expiration of the period of Tender validity specified on the Letter of Tender or any extension thereof.</p>
<p>ITT 25</p>	<p>Replace ITT 25 with the following:</p> <p>25.1 The Purchaser shall conduct the electronic opening of Technical Part on eProcurement portal on the date, time and place as specified below: Street Address: Haryana Rail Infrastructure Development Corporation Limited (HRIDC), Plot no.143, Railtel Tower, Sector-44 Floor/ Room number: 5th floor City: Gurugram Zip code: 122003 Country: INDIA Date: 22.11.2023</p> <p>Time: 1530 hrs IST</p> <p>The opening of the Technical Part and subsequent details can be viewed by the Tenderers by logging on the eProcurement portal. Alternatively, any Tenderer who wish to attend the Technical Part opening can be present during the opening. The Tenderer’s representatives who are present shall be requested to mark their attendance on the format available with the Purchaser.</p> <p>25.2 The Financial Part submitted online on eProcurement portal will remain unopened in the eProcurement portal until the date and time of opening of Financial Part. The date and time of the opening of the Financial Part will be notified to all the Tenderers on eProcurement portal whose tender is found to be substantially responsive and qualified in technical evaluation as specified in ITT 34.2.</p> <p>25.3 At the time of opening of Technical Part, the following shall be read out and recorded:</p> <ul style="list-style-type: none"> (a) the name of the Tenderer; (b) the presence of a Tender Security; and (c) any other details as the Purchaser may consider appropriate.

	<p>Only Technical Part read out and recorded at Tender opening shall be considered for evaluation.</p> <p>25.4 The Purchaser shall prepare a record of the opening of Technical Part that shall include, as a minimum, the name of the Tenderer and the presence or absence of Tender Security. The Tenderer’s representatives who are present shall be requested to sign the record available with the HRIDC. The omission of a Tenderer’s signature on the record shall not invalidate the contents and effect of the record.</p> <p>25.5 At the Tender opening the Purchaser shall neither discuss the merits of any Tender nor reject any Tender.</p> <p>25.6 Following the completion of the evaluation of the Technical Parts of the Tenders, and the Bank has issued its no objection, the Purchaser shall notify in writing those Tenderers whose Tenders were considered non-responsive to the Tender Document or failed to meet the Qualification Criteria, advising them of the following information:</p> <ul style="list-style-type: none">(a) the grounds on which their Technical Part of Tender failed to meet the requirements of the Tender Document;(b) their “FINANCIAL PART” shall remain unopened on the eProcurement portal;(c) notify them of the date, time and location of the public opening of “FINANCIAL PART” on the eProcurement portal; <p>25.7 The Purchaser shall, simultaneously, notify in writing those Tenderers whose Tenders - Technical Parts have been evaluated as substantially responsive to the Tender Document and met all Qualifying Criteria, advising them of the following information:</p> <ul style="list-style-type: none">(a) their Tender has been evaluated as substantially responsive to the Tender Document requirements and met the Qualification Criteria;(b) their “FINANCIAL PART” on eProcurement portal will be opened at the public opening of the Financial Parts; and(c) notify them of the date, time and location of the public opening of the “FINANCIAL PART” as specified below:<ul style="list-style-type: none">i. The Purchaser shall publish a notice of the public opening of the Financial Parts on eProcurement portal.ii. Any interested party who wishes to attend this public opening may contact:
--	---

	<p>For the attention: GM/IP&IT Haryana Rail Infrastructure Development Corporation Limited</p> <p>Email address: horc.etendering@gmail.com</p> <p>25.8 The “FINANCIAL PART” of Tenderers who met the Qualification Criteria and whose Tenders were evaluated as substantially responsive, will be opened on eProcurement portal. The Purchaser shall read out the names of each Tenderer, and the total Tender prices, including any discounts and any other details as the Purchaser may consider appropriate.</p> <p>25.9 The Purchaser shall neither discuss with Tenderer’s representative present, if any, the merits of any Tender nor reject any “FINANCIAL PART”.</p> <p>25.10 The Purchaser shall prepare a record of the Financial Part of the Tender opening that shall include, as a minimum:</p> <ul style="list-style-type: none"> (a) the name of the Tenderer whose Financial Part was opened; and (b) the Tender price <p>25.11 The Tenderer’s representatives who are present at the time of opening of Financial Part shall be requested to sign the record. The omission of a Tenderer’s signature on the record shall not invalidate the contents and effect of the record. A copy of the record (i.e. summary of rates quoted) can be viewed by all eligible Tenderers after opening of the Financial Part.</p>
<p>E. Evaluation and Comparison of Tenders</p>	
<p>ITT 27</p>	<p>Replace ITT 27 with the following:</p> <p>27.1 To assist in the examination, evaluation and comparison of the Tenders, the Purchaser may, at its discretion, ask any Tenderer for a clarification of its Tender in accordance with ITT Clause 30. Any clarification submitted by a Tenderer that is not in response to a request by the Purchaser shall not be considered. The Purchaser’s request for clarification and the response shall be in writing and delivered to concerned Tenderers (by courier or e-mail through PDF attachment). The due date and time to respond to these queries will also be communicated. No change in the prices or substance of the Tender shall be sought, offered, or permitted, except to confirm the correction of errors discovered by the Purchaser in the evaluation of the Financial Part, in accordance with ITT Clause 35.</p>

	27.2 If a Tenderer does not provide clarifications of its Tender by the date and time set in the Purchaser’s request for clarification, their Tender shall be evaluated as per the available information in the submitted Tender.
ITT 30.3	Not Applicable
ITT 32.1	The currency that shall be used for Tender evaluation and comparison purposes is Indian Rupees (INR) only.
ITT 33.1	Provisions for development of domestic industry (such as a margin of domestic preference <i>shall not</i> apply).
ITT 34.1	<p>Replace ITT 34.1 with the following:</p> <p>Evaluation of Technical Part of Tender</p> <p>34.1.1 The Purchaser shall use the criteria and methodologies listed in this ITT and Section III, Evaluation and Qualification criteria.</p> <p>34.1.2 The Purchaser shall determine, to its satisfaction that whether Eligible Tenderers that have submitted substantially responsive Tender-Technical Part meets the qualifying criteria specified in Section III, Evaluation and Qualification Criteria.</p> <p>34.1.3 The determination shall be based upon an examination of the documentary evidence of the Tenderer’s qualifications submitted by the Tenderer, pursuant to ITT 17. The determination shall not take into consideration the qualifications of other firms such as the Tenderer’s subsidiaries, parent entities, affiliates, subcontractors (other than specialized subcontractors if permitted in the Tender Document), or any other firm(s) different from the Tenderer.</p> <p>34.1.4 Only Tenders that are both substantially responsive to the Tender Document, and meet all Qualification Criteria, shall be notified on eProcurement portal for the public opening of “FINANCIAL PART”.</p>
ITT 34.2	<p>Replace ITT 34.2 with the following:</p> <p>Evaluation of Financial Part of Tender</p> <p>34.2 To evaluate a Financial Part of the Tender, the Purchaser shall consider the following:</p> <ul style="list-style-type: none"> (a) Financial Part submission in accordance with ITT 11.1.3; (b) the Tender Price as quoted in accordance with ITT 14;

	<p>(c) price adjustment for correction of arithmetical errors in accordance with ITT 31.1;</p> <p>(d) converting the amount resulting from applying (b) to (c) above, if relevant, to a single currency in accordance with ITT 32;</p>
ITT 34.4	Not Applicable
ITT 34.5	Not Applicable
ITT 34.6	Not Applicable
ITT 35.1	<p>Replace ITT 35.1 with the following:</p> <p>The Purchaser shall compare the evaluated costs of all substantially responsive Tenders established in accordance with ITT 34.2 to determine the Tender that has the lowest evaluated cost.</p>
ITT 37	Deleted
	F. Award of Contract
ITT 42	<p>The maximum percentage by which quantities may be increased is: 30% [Thirty percentage]</p> <p>The maximum percentage by which quantities may be decreased is: 30% [Thirty percentage]</p>
ITT 43.1	<p>Add the following to ITT 43.1</p> <p>The Accepted Contract Amount shall be in INR only.</p>
ITT 45.1	The successful Tenderer <i>shall not</i> submit the Beneficial Ownership Disclosure Form.
ITT 47.1	<p>The procedures for making a Procurement-related Complaint are detailed in the Bank's Procurement Instructions for Recipients (Annex IV). If a Tenderer wishes to make a Procurement-related Complaint, the Tenderer should submit its complaint following these procedures, in writing (by the quickest means available, such as by email or fax), to:</p> <p>For the attention: GM (IP&IT) Purchaser: Haryana Rail Infrastructure Development Corporation Limited (HRIDC) Email address: horc.etendering@gmail.com</p> <p>In summary, a Procurement related Complaint may challenge any of the following:</p>

	<ol style="list-style-type: none">1. the terms of the Tender Documents; and2. the Purchaser's decision to award the contract.
--	--

Page intentionally left Blank

Section III - Evaluation and Qualification Criteria

1. General Provisions

1.1 Evaluation Sequence

- (a) Tenders will be evaluated through the following three stages:
 - (i) Stage 1: Evaluation of Administrative Requirements
 - (ii) Stage 2: Evaluation of Compliance with the Qualification Requirements
 - (iii) Stage 3: Financial Evaluation

1.2 Deleted

1.3 Tender Forms

- (a) Tenderers should note that the information required to be inserted into the Tender Forms shall be comprehensive and detailed. The technical information shall be furnished in line with the requirements of Part 1, Part 2 and Part 3 of the Tender Documents.
- (b) All Forms contained in the Tender Documents must be fully and properly completed and all the forms must be returned duly signed by Authorised Representative of the Tenderer, as they will be reviewed exactly as submitted and errors or omissions may count against the Tenderer.
- (c) Any Tenderer who is found to have intentionally submitted false or inaccurate statements/information shall be disqualified from the Tendering process.

Page intentionally left Blank

2. Stages of Evaluation

2.1 Stage 1: Evaluation of Administrative Requirements

A. General

- (a) The Stage 1 Evaluation will consist of checking the Tenders to confirm whether they are substantially responsive to the administrative requirements of the Tender Documents.
- (b) The following administrative items will be checked:
 - (i) Whether the Tender submission is in accordance with ITT 11.1.2;
 - (ii) Whether the Power of Attorney (POA) for the Tender signatory is in the correct form [Ref. ITT 20.3]. If during technical evaluation stage, POA submitted by the Tenderer is not found in the correct format, Purchaser will send written (Courier/email with PDF attachment) request to the Authorized Representative for rectification of POA in accordance with format prescribed in Section IV, Tender Forms, specifying the deadline for receipt of Power of Attorney in correct form. If a tenderer does not provide the Power of Attorney in correct form within the stated date and time set in the Purchaser's request for correction of Power of Attorney, its Tender is liable to be rejected.

2.2 Stage 2: Evaluation of Compliance with the Qualification Requirements

B. General

Tenders will be reviewed to ascertain whether the Tender complies with all of the minimum requirements as stipulated in the Sub-Clause C. Qualification Criteria.

C. Check Items

The following requirements of the Instruction to Tenderers, Clauses 4, 11 & 17 will be checked to ensure compliance to the requirements of criteria given below:

(a) Eligibility

- (i) Nationality: Form ELI-1.1
- (ii) Conflict Interest: Letter of Tender-Technical Part
- (iii) Bank Eligibility: Letter of Tender -Technical Part
- (iv) State-owned Enterprise or Institution of the Recipient country: Form ELI-1.1 and Letter of Tender -Technical Part
- (v) United Nations resolution or Recipient's country law: Letter of Tender-Technical Part

(b) Historical Contract Non-Performance and Litigation

- (i) History of Non-Performing Contracts: Form CON-1
- (ii) Suspension Based on Execution of Tender- Securing Declaration by the Purchaser: Letter of Tender-Technical Part
- (iii) Pending Litigation: Form CON-1

(c) Financial Situation

- (i) Financial Situation and Performance: Form FIN-3.3.1

(d) Financial Resources

- (i) Financial Resources: Form FIN-3.3.3
- (ii) Average Net Worth and Net Worth: Form FIN 3.3.1

(e) Experience

- (i) Supply Experience: Form EXP-3.4.1
- (ii) Production Capacity: Form EXP-3.4.2

3. Qualification Criteria

If the Tenderer fails to comply with any item of Qualification Criteria given below, the Tenderer shall be disqualified.

No.	Subject	Requirement	Single Entity	Joint Venture (Not Permitted)			Submission Requirements
				All Members Combined	Each Member	Lead Member	
3.1 Eligibility							
3.1.1	Nationality	Nationality in accordance with ITT 4.4	Must meet requirement	N/A	N/A	N/A	Forms ELI – 1.1
3.1.2	Conflict of Interest	No conflicts of interest in accordance with ITT 4.2	Must meet requirement	N/A	N/A	N/A	Letter of Tender-Technical Part
3.1.3	Bank Eligibility	Not having been declared ineligible by the Bank, as described in ITT 4.5.	Must meet requirement	N/A	N/A	N/A	Letter of Tender-Technical Part
3.1.4	State-owned Enterprise or Institution of the Recipient country	Meets conditions of ITT 4.6	Must meet requirement	N/A	N/A	N/A	Letter of Tender-Technical Part and Form ELI – 1.1

No.	Subject	Requirement	Single Entity	Joint Venture (Not Permitted)			Submission Requirements
				All Members Combined	Each Member	Lead Member	
3.1.5	United Nations resolution or Recipient's country law	Not having been excluded as a result of prohibition in the Recipient's country laws or official regulations against commercial relations with the Tenderer's country, or by an act of compliance with UN Security Council resolution, both in accordance with ITT 4.8 and Section V.	Must meet requirement	N/A	N/A	N/A	Letter of Tender-Technical Part
3.1.6	Share of JV members	JV Not Permitted	N/A	N/A	N/A	N/A	-
3.2 Historical Contract Non-Performance							
3.2.1	History of Non-Performing Contracts	Non-performance of a contract ¹ did not occur as a result of Supplier default since 1 st April 2018 till 28	Must meet requirement	N/A	N/A	N/A	Form CON-1

¹ Nonperformance, as decided by the Purchaser, shall include all contracts terminated by the Purchaser where (a) nonperformance was not challenged by the Supplier, including through referral to the dispute resolution mechanism under the respective contract, and (b) contracts that were so challenged but fully settled against the Supplier. Nonperformance shall not include contracts where Purchaser's decision was overruled by the dispute resolution mechanism. Nonperformance must be based on all information on fully settled disputes or litigation, i.e., dispute or litigation that has been resolved in accordance with the dispute resolution mechanism under the respective contract and where all appeal instances available to the Tenderer have been exhausted.

No.	Subject	Requirement	Single Entity	Joint Venture (Not Permitted)			Submission Requirements
				All Members Combined	Each Member	Lead Member	
		days prior to deadline of Tender submission.					
3.2.2	Suspension Based on Execution of Tender-Securing Declaration by the Purchaser	Not under suspension based on-execution of a Tender/Proposal Securing Declaration pursuant to ITT 4.7 and ITT 19.9	Must meet requirement	N/A	N/A	N/A	Letter of Tender – Technical Part
3.2.3	Pending Litigation	Tenderer’s financial position and prospective long-term profitability still sound according to criteria established in 3.3.1 (ii) below and assuming that all pending litigation and arbitration ² will be resolved against the Tenderer.	Must meet requirement	N/A	N/A	N/A	Form CON-1
3.2.4	Declaration: Litigation History	Declare History of court/arbitral award decisions against the Tenderer since 1st April 2018 till 28 days prior to	Must make the declaration	N/A	N/A	N/A	Form CON-1

² The Tenderer shall provide accurate information in the Tender Form CON-1 about any litigation and arbitration resulting from contracts completed or ongoing under its execution till 28 days prior to deadline of Tender submission.

No.	Subject	Requirement	Single Entity	Joint Venture (Not Permitted)			Submission Requirements
				All Members Combined	Each Member	Lead Member	
		deadline of Tender submission.					
3.2.5	Declaration: Environmental, Social, Health, and Safety (ESHS) past performance	Declare any civil work contracts that have been suspended or terminated and/or performance security called by an Purchaser for reasons related to the non-compliance of any environmental, or social, or health, or safety requirements or safeguard in the past five years ³ preceding 28 days prior to deadline of Tender submission	Must make the declaration	N/A	Must make the declaration.	Must make the declaration	Form CON-2 ESHS Performance Declaration
3.3 Financial Situation and Performance							
3.3.1	Financial Capabilities	i) The Tenderer shall demonstrate that it has access to, or has available, liquid assets, unencumbered real assets, lines of credit, and other	Must meet requirement	N/A	N/A	N/A	Form FIN-3.3.3 (Sources of Finance for the subject Contract)

³ The Purchaser may use this information to seek further information or clarifications in carrying out its due diligence.

No.	Subject	Requirement	Single Entity	Joint Venture (Not Permitted)			Submission Requirements
				All Members Combined	Each Member	Lead Member	
		financial means (independent of any contractual advance payment) sufficient to meet the construction cash flow requirements estimated as INR 40 million or the equivalent amount in a freely convertible currency for the subject contract (i.e. PSC-1).					
		(ii) The Tenderer must demonstrate the current soundness of its financial position and indicate its prospective long-term profitability. As a minimum, a) Average Net-Worth (Total Assets – Total Liabilities)* during the last three (03) financial years should be positive and b) the Net-Worth during the last financial year must be positive .	Must meet requirement	N/A	N/A	N/A	Form FIN-3.3.1

No.	Subject	Requirement	Single Entity	Joint Venture (Not Permitted)			Submission Requirements
				All Members Combined	Each Member	Lead Member	
		<p>*Note: Amount in dispute against the Tenderer corresponding to all pending litigations and arbitration resulting from contracts completed or ongoing under its execution, considering that these will be resolved against the Tenderer (as per Form CON-1 item 2 and 3), will be subtracted from the Average Net Worth calculated above.</p>					
3.4 Technical Qualification and Experience							
3.4.1	RDSO certifications of Concrete Sleeper Plants (CSPs) Plant/Production facility	<p>The tenderer (Concrete Sleeper Plant i.e CSP) must, fulfill all the following conditions to be eligible for placement of regular orders against this tender:</p> <p>(i) Concrete Sleeper Plants (CSPs) certified by RDSO for undertaking production of PSC Main Line sleepers or</p>	Must meet requirement				

No.	Subject	Requirement	Single Entity	Joint Venture (Not Permitted)			Submission Requirements
				All Members Combined	Each Member	Lead Member	
		any other category PSC sleepers for IR will be considered eligible for placement of orders (regular as per status of RDSO approval/certification) against this tender.					
3.4.2	Available Production Capacity	The tenderer shall have the available production capacity more than the 5,30,000 quantity. The tenderer shall submit the required data in Form EXP-3.4.2 for calculation of available production capacity.	Must meet requirement				

Notes:

1. Existing manufacturers quoting for supply from a new location after shifting their existing plant should have prior approval for supply from new location as per instructions of Railway Board vide letter No. 2004/Tk-II/22/11/5 dated 22.02.2006.
Plants, which have already been permitted for shifting of location but have not shifted/started production from new location, even after lapse of one year or more from date of issue of permission letter, shall not be eligible to quote from old location. They will be eligible to quote from new location only if they have already obtained the RDSO certification of Plant at new location, before the date of tender opening.
2. Those plants will be considered “closed”, which have not manufactured any type of sleepers (mainline, Turnout, special sleepers) for more than five years reckoning from the date of tender opening. Such plants will not be eligible for tender until and unless fresh RDSO certification/approval is obtained and placed on record.

Checklist-CL

Checklist of submission of Documents/Forms online, duly filled
(Reference to TDS-ITT 11.1.2 & 11.1.3, Section II, Part 1)

A. TECHNICAL PART

S. No.	Requirement of Tender Document	Ref. Clause of Tender documents	Tenderer's Name:	
			Whether information submitted (Yes/No/N.A.)	Ref. Pg No. in the Technical Submittal
1.	Letter of Tender-Technical Part	ITT 11.2 (a) and Section IV		
2.	Technical Part signed by authorized representative of Single Entity/Joint Venture	ITT 20.3		
3.	Tender Security- Online Receipt	ITT 19.1, ITT 19.3 and Appendix E of Section IV		
4.	Form ELI – 1.1: Tenderer Information Form (Single Entity)	ITT 17.1 and Appendix D of Section IV		
5.	Form ELI-1.2: Power of Attorney (POA) for Submitting Tender	ITT 20.3 and Appendix D of Section IV		
6.	Board Resolution in case of a Public/Private limited company/LLP	TDS ITT 20.3		
7.	Incorporation Certificate and Memorandum and Articles of Association (MOA & AOA) (in case of Private/Public Limited Company)	Note (iii) (d) of Form ELI 1.4		
8.	Incorporation Certificate and Limited Liability Membership Agreement in case of Limited Liability Membership firms.	Note (iii) (e) of Form ELI 1.4		
9.	Proprietorship Affidavit (in case the Tenderer is Proprietorship Tenderer)	Note (iii) (a) of Form ELI 1.4		
10.	Partnership Deed (in case the Tenderer is Partnership Firm)	Note (iii) (b) of Form ELI 1.4		
11.	Form CON - 1: Historical Contract Non-Performance, Pending Litigation and Litigation History	ITT 17.2 and Appendix D of Section IV		
12.	Form CON - 2: Environmental, Social, Health, and Safety Performance Declaration	ITT 17.2 and Appendix D of Section IV		

S. No.	Requirement of Tender Document	Ref. Clause of Tender documents	Tenderer's Name:	
			Whether information submitted (Yes/No/N.A.)	Ref. Pg No. in the Technical Submittal
13.	Form FIN – 3.3.1: Financial Situation and Performance	ITT 17.2 and Appendix D of Section IV		
14.	Form FIN – 3.3.3: Financial Resources	ITT 17.2 and Appendix D of Section IV		
15.	Form EXP – 3.4.1: RDSO certifications of Concrete Sleeper Plants (CSPs) Plant/Production facility	ITT 17.2 and Appendix D of Section IV		
16.	Form EXP – 3.4.2: Available Production Capacity	ITT 17.2 and Appendix D of Section IV		
<p>Note:</p> <p>(i) The check list is indicative and not exhaustive. The Tenderer must go through the complete tender documents and submit the required documents accordingly.</p> <p>(ii) If any of the above form or criteria is not applicable to the Tenderer, then they can simply indicate N.A. against the relevant column</p> <p>(iii) All Tender Forms contained in the Tender Documents must be fully and properly completed and all the forms must be returned signed by Authorized Representative of the Tenderer.</p>				

B. FINANCIAL PART

The Financial Part is provided in the Tender Documents in the form of MS-EXCEL file and PDF file. The Contract Price for the Works shall be quoted in the MS-EXCEL file provided in the eProcurement portal. The Tenderer shall download the MS-EXCEL file and after quoting their Contract Price, upload the same along with other PDF documents of Financial Part mentioned in (a) below as a ZIP file on eProcurement portal. The quoted Contract Price shall not be offered/quoted elsewhere in the Technical Part submission/ Tender submission. These prices shall include all costs associated with the contract including GST. The Tenderer shall complete the Financial Part in accordance with the instructions given in the Financial Part.

Following information are required to be submitted by Tenderers in their Financial Part:

(a) In PDF File

1. Letter of Tender – Financial Part
2. Appendix A to Financial Part: Schedule of Adjustment Data
3. Appendix B to Financial Part: Bill of Quantities

Contract Price comprises of the following Schedule:

Schedule	Description	Remarks
Bill of Quantities	Manufacture and Supply of Pre-stressed Mono Block Concrete Line Sleepers conforming to RDSO Drg. No. T-8746 in connection with laying of New BG Double Railway Line from Prithla to New Harsana Kalan of Haryana Orbital Rail Corridor (HORC) Project.	Quoted single percentage (%) Excess (+) or Less (-) on the estimated amount in the prescribed place of Price Schedule in MS-Excel file of Financial Part.

(b) In MS-Excel File

Bill of Quantities for quoting rates for the supply.

I hereby confirm that:

- (i) I have checked the above list with our submittal. I am also aware that if our tender is not containing the above documents, the Purchaser has the right to reject our tender.
- (ii) All the pages of tender submission are properly indexed and numbered.

Seal:

Date:

(Signature of Authorized representative of Tenderer)

Page intentionally left Blank

Section IV - Tender Forms**Forms**

Letter of Tender-Technical Part	70
Form ELI-1.1	73
Form ELI 1.2.....	74
Form ELI-1.3	75
Form CON-1	77
Form FIN-3.3.1:	81
Form FIN-3.3.2:	85
Form FIN-3.3.3:	86
Form EXP-3.4.1	88
Form EXP-3.4.2.....	90
Tender Security	93
Tender-Securing Declaration	96
Deleted	96
Manufacturer’s Authorization	97
Country of Origin Declaration Form	98
Letter of Tender – Financial Part	99
Price Schedule.....	103

Letter of Tender-Technical Part

INSTRUCTIONS TO TENDERERS: DELETE THIS BOX ONCE YOU HAVE COMPLETED THE DOCUMENT

The Tenderer must prepare this Letter of Tender on stationery with its letterhead clearly showing the Tenderer's complete name and business address.

Note: All italicized text is to help Tenderers in preparing this form.

Date of this Tender submission: *[insert date (as day, month and year) of tender submission]*

Tender No.: *HORC/HRIDC/PSC-01/2023*

Tender Name: *[insert the tender name]*

To:

GM/IP&IT,

Haryana Rail Infrastructure Development Corporation Limited (HRIDC),

Plot no.143, 5th floor,

Railtel Tower, Sector-44

Gurugram – 122003

Tel: +91 7011056770

We, the undersigned, hereby submit our Tender, in two parts sealed separately, namely: (a) the Technical Part; and (b) the Financial Part.

In submitting our Tender, we declare that:

- (a) **No Reservations:** We have examined and have no reservations to the Tender Document, including Addenda/Corrigenda issued in accordance with Instructions to Tenderers (ITT 8).
- (b) **Eligibility:** We meet the eligibility requirements and have no conflict of interest in accordance with ITT 4.
- (c) **Tender-Securing Declaration:** We have not been suspended nor declared ineligible by the Purchaser based on execution of a Tender-Securing Declaration or Proposal-Securing Declaration in the Purchaser's Country in accordance with ITT 4.7.
- (d) **Conformity:** We offer to supply in conformity with the Tender Document and in accordance with the Delivery Schedules specified in the Schedule of Requirements the following Goods: *[insert a brief description of the Goods and Related Services]*.
- (e) **Tender Validity Period:** Our Tender shall be valid for the period specified in TDS 18.1 (as amended, if applicable) after the date fixed for the Tender submission deadline specified in TDS

22.1 (as amended, if applicable), and it shall remain binding upon us and may be accepted at any time before the expiration of that period.

- (f) **Performance Security:** If our Tender is accepted, we commit to obtain a performance security in accordance with the Tender Document.
- (g) **One Tender per Tenderer:** We are not participating, as a Tenderer, either individually or as a Joint Venture member, in more than one Tender in this tendering process, and meet the requirements of ITT 4.3, other than alternative Tenders submitted in accordance with ITT 13.
- (h) **Suspension and Debarment:** We, along with any of our subcontractors, suppliers, consultants, manufacturers or service providers for any part of the contract, are not subject to, and not controlled by any entity or individual that is subject to, a temporary suspension or a debarment or any ineligibility imposed or recognized by the Bank. Further, we are not ineligible under the Purchaser's Country laws or official regulations or pursuant to a decision of the United Nations Security Council.
- (i) **State-Owned Enterprise or Institution:** *[select the appropriate option and delete the other]* *[We are not a state-owned enterprise or institution]* / *[We are a state-owned enterprise or institution but meet the requirements of ITT 4.6].*
- (j) **Binding Contract:** We understand that this Tender, together with your written acceptance thereof included in your Letter of Acceptance, shall constitute a binding contract between us, until a formal contract is prepared and executed.
- (k) **Purchaser Not Bound to Accept:** We understand that you are not bound to accept the lowest evaluated cost Tender, the Most Advantageous Tender or any other Tender that you may receive.
- (l) **Prohibited Practice:** We hereby certify that we have taken steps to ensure that no person acting for us or on our behalf engages in any type of Prohibited Practice.
- (m) **Inspection and Audit:** We agree to permit the Bank or its representative to inspect our accounts and records and other documents relating to the tender submission and to have them audited by auditors appointed by the Bank.
- (n) We declare and certify that we have not made any misleading or false representation in the forms, statements and attachments in proof of the qualification requirements.
- (o) We declare that the information and documents submitted along with the tender by us are correct and we are fully responsible for the correctness of the information and documents, submitted by us.
- (p) *[select the appropriate option and delete whichever is not applicable]* *[We declare and certify that financial data as per the balance sheets for last three financial years including that for the latest concluded financial year are being submitted]* **OR** *[We declare and certify that balance sheet for the latest concluded financial year has not been finalized till*

date and that is why we are furnishing financial data for last three financial years ignoring the latest concluded financial year.]

- (q) I/we have downloaded the Tender Document/addenda/corrigenda/ clarifications along with the set of enclosures hosted on eProcurement portal as mentioned in Tender Document. I/We verified the content of the document from the website and there is no addition, no deletion or no alteration to the content of the Tender Document. In case of any discrepancy noticed at any stage i.e. evaluation of Tenders, execution of work or final payment of the Contract, the master copy of Tender Document available with HRIDC shall be final and binding upon me/us.

Name of the Tenderer: *[insert complete name of the Tenderer]

Name of the person duly authorized to sign the Tender on behalf of the Tenderer: **[insert complete name of person duly authorized to sign the Tender]

Title of the person signing the Tender: [insert complete title of the person signing the Tender]

Signature of the person named above: [insert signature of person whose name and capacity are shown above]

Date signed [insert date of signing] **day of** [insert month], [insert year]

** : Person signing the Tender shall have the power of attorney given by the Tenderer. The power of attorney shall be attached with the Letter of Tender-Technical Part.

Form ELI-1.1

Tenderer Information Form (Single Entity)

[Ref. ITT Sub-Clause 17.1]

Date: _____
 Tender No. and title: _____
 Page _____ of _____ pages

Tenderer's name
Tenderer's actual or intended country of registration: <i>[indicate country of Constitution]</i>
Tenderer's actual or intended year of incorporation:
Tenderer's legal address [in country of registration]:
Tenderer's authorized representative information Name: _____ Address: _____ Mobile number: _____ Telephone/Fax numbers: _____ E-mail address: _____
<p>1. Attached are copies of original documents of</p> <p><input type="checkbox"/> Articles of Incorporation (or equivalent documents of constitution or association), and/or documents of registration of the legal entity named above, in accordance with ITT 4.4</p> <p><input type="checkbox"/> In case of state-owned enterprise or institution, in accordance with ITT 4.6, documents establishing:</p> <ul style="list-style-type: none"> • Operation on a commercial basis; • Financial and managerial autonomy; • Day-to-day management not controlled by the government; and Not under the supervision of the Purchaser or its procuring agency.

Tenderer's Authorized Representative

Signature:
 Date:
 Company stamp:

Form ELI 1.2

Tenderer's Joint Venture Members Information Form

Deleted

Form ELI-1.3

[Ref. ITT Sub-Clause 20.3]

**Power of Attorney (POA) for Submitting Tender
(For Single Entity/Sole Tenderer only)**

(To be executed on non-judicial stamp paper of the appropriate value in accordance with relevant stamp Act. The stamp paper to be in the name of the company who is issuing the Power of Attorney)

Know all men by these presents, we..... (name and address of the registered office) do hereby constitute, appoint and authorise Mr/Ms..... (name and residential address) who is presently employed with us and holding the position ofas our attorney, to do in our name and on our behalf, all such acts, deeds and things necessary in connection with or incidental to our tender for the supply of **PSC-01: Manufacture and Supply of Pre-stressed Mono Block Concrete Line Sleepers conforming to RDSO Drg. No. T-8746 in connection with laying of New BG Double Railway Line from Prithla to New Harsana Kalan of Haryana Orbital Rail Corridor (HORC) Project** including signing and submission of all documents and providing information/responses to Haryana Rail Infrastructure Development Corporation Ltd (HRIDC), representing us in all matters before HRIDC, and generally dealing with HRIDC in all matters in connection with our tender for the said project.

We hereby agree to ratify all acts, deeds and things lawfully done by our said attorney pursuant to this Power of Attorney and that all acts, deeds and things done by our aforesaid attorney shall and shall always be deemed to have been done by us.

..... (Signature)
(Name, Title and address) of the **Person Accepting the POA.**

..... (Signature)
(Name, Title and address) of the **Person issuing the POA**

Notes:

- i. The tenderer should submit the notarised Power of Attorney. In case of Foreign Members, Power of Attorney(s) and Board Resolution confirming authority on the persons issuing the Power of Attorney for such actions shall be submitted duly notarized by the notary public of country of origin and should be either stamped by Indian Embassy/High Commission or Member Countries of Hague convention may submit these document with “Apostille” stamp. Also, in case the documents are in foreign language the translation of the same shall be authenticated by Embassy/High Commission.
- ii. The mode of execution of the Power of Attorney should be in accordance with the procedure, if any, laid down by the applicable law and the charter documents of the

executant(s) and when it is so required the same should be under common seal affixed in accordance with the required procedure.

iii. The tenderer should submit following additional document in support of the POA as case to case basis:

- a) Proprietorship Affidavit in case of Proprietary Tenderer.
- b) Partnership Deed in case of Partnership Firms.
- c) Board Resolution in case of a Public/Private limited company/LLP.
- d) Incorporation Certificate and Memorandum & Article of Association in case of a Public/Private limited company.
- e) Incorporation Certificate and Limited Liability Membership Agreement in case of Limited Liability Membership firms.

Form CON-1

Historical Contract Non-Performance, Pending Litigation and Litigation History

[Ref. ITT Sub-Clause 17.2 and Section III, Evaluation and Qualification Criteria, Sub-Clause 3.2.1 and Sub-Clause 3.2.3]

[The following table shall be filled in for the Tenderer]

Tender No.: HORC/HRIDC/PSC-01 /2023

Tenderer's Name: _____

Page _____ of _____ pages

1. Non-Performed Contracts in accordance with Section III, Evaluation and Qualification Criteria				
Description				YES/NO
(i) Whether Contract(s) Non-Performance occurred as a result of Supplier's default since 1st April 2018 specified in Section III, Evaluation and Qualification Criteria, requirement 3.2.1				
(ii) If answer to (i) above is YES, then following details to be submitted:				
S. No.	Year	Non-performed portion of contract	Contract Identification	Total Contract Amount (current value, currency, exchange rate and INR equivalent)
	[insert year]	[insert amount and percentage]	Contract Identification: [indicate complete contract name/ number, and any other identification] Name of Purchaser: [insert full name] Address of Purchaser: [insert street/city/country] Reason(s) for nonperformance: [indicate main reason(s)]	[insert amount]

2. Pending Litigation resulting from contracts completed or in ongoing contracts, in accordance with Section III, Evaluation and Qualification Criteria	
Description	YES/NO
(i) Whether any litigation is still pending against the Supplier in accordance with Section III, Evaluation and Qualification Criteria, Sub-Clause 3.2.3.	
(ii) If answer to (i) above is YES, then following details to be submitted:	

S. No.	Year of dispute	Amount in dispute initiated by the Tenderer (currency)	Amount in dispute against Tenderer (currency)	Contract Identification	Total Contract Amount (currency), INR Equivalent (exchange rate)
				Contract Identification: _____ Name of Purchaser: _____ Address of Purchaser: _____ Matter in dispute: _____ Party who initiated the dispute: _____ Status of dispute: _____	
				Contract Identification: Name of Purchaser: Address of Purchaser: Matter in dispute: Party who initiated the dispute: Status of dispute:	
Total Amount in dispute against Tenderer under pending litigation (INR Equivalent), (A)					

3.	Pending Arbitration resulting from contracts completed or in ongoing contracts, in accordance with Section III, Evaluation and Qualification Criteria				
Description					YES/NO
(i)	Whether any arbitration is still pending against the Supplier in accordance with Section III, Evaluation and Qualification Criteria, Sub-Clause 3.2.3.				
(ii)	If answer to (i) above is YES, then following details to be submitted:				
S. No.	Year of dispute	Amount in dispute initiated by the Tenderer (currency)	Amount in dispute against Tenderer (currency)	Contract Identification	Total Contract Amount (currency), INR Equivalent (exchange rate)

			Contract Identification: _____ Name of Purchaser: _____ Address of Purchaser: _____ Matter in dispute: _____ Party who initiated the dispute: _____ Status of dispute: _____	
			Contract Identification: Name of Purchaser: Address of Purchaser: Matter in dispute: Party who initiated the dispute: Status of dispute:	
Total Amount in dispute against Tenderer in Arbitration (INR Equivalent), (B)				
Total Amount in dispute against Tenderer under pending litigation and Arbitration (INR Equivalent), C= (A) + (B)				

4. Litigation History in accordance with Section III, Evaluation and Qualification Criteria				
Description				YES/NO
(i) Whether any Litigation History in accordance with Section III, Evaluation and Qualification Criteria, Sub-Clause 3.2.4.				
(ii) If answer to (i) above is YES, Litigation History in accordance with Section III, Evaluation and Qualification Criteria, Sub-Clause 3.2.4 is indicated below.				
S. No.	Year of award	Outcome as percentage of Net Worth	Contract Identification	Total Contract Amount (currency), INR Equivalent (exchange rate)
	<i>[insert year]</i>	<i>[insert percentage]</i>	Contract Identification: [indicate complete contract name, number, and any other identification] Name of Purchaser: <i>[insert full name]</i> Address of Purchaser: <i>[insert street/city/country]</i> Matter in dispute: <i>[indicate main issues in dispute]</i> Party who initiated the dispute: <i>[indicate "Purchaser" or "Contractor"]</i> Reason(s) for Litigation and award decision <i>[indicate main reason(s)]</i>	<i>[insert amount]</i>

Tenderer's Authorized Representative

Signature:
Date:
Company stamp:

Chartered Accountant/Company Auditor/Statutory Auditor

Certified that the information furnished above is correct as per the audited balance sheets of the entity.

Signature:
Name:
Position:
Date:

Note: The Tenderer shall provide accurate information in Form CON-1 about any pending litigation and pending arbitration resulting from contracts completed or in ongoing contracts till 28 days prior to deadline of Tender submission..

Form CON-2

**Environmental, Social, Health, and Safety
Performance Declaration**

[Ref. ITT Sub-Clause 17.2 and Section III, Evaluation and Qualification Criteria, Sub-Clause 3.2.5]

[The following table shall be filled in for the Tenderer or in case of JV, each member of a Joint Venture]

Tender No.: HORC/HRIDC/PSC-01/2023

Tenderer's Name: _____

JV Member's Name _____

Page _____ of _____ pages

Environmental, Social, Health, and Safety Performance Declaration in accordance with Sub-Clause 3.2.5, Section III, Qualification Criteria and Requirements			
Description			YES/NO
<p>(i) Declaration of suspension or termination of contract: Whether contract(s) has/have been suspended or terminated and/or Performance Security called by an Purchaser(s) for reasons related to Environmental, Social, Health, or Safety (ESHS) performance since the date specified in Section III, Qualification Criteria, and Requirements, Sub-Clause 3.2.5.</p>			
<p>(ii) If answer to (i) above is YES, then following details to be submitted:</p>			
a. Details of Contract(s) suspended/terminated by an Purchaser(s) for reasons related to ESHS performance			
Year	Suspended or terminated portion of contract	Contract Identification	Total Contract Amount (current value, currency, exchange rate and INR equivalent)
<i>[insert year]</i>	<i>[insert amount and percentage]</i>	Contract Identification: <i>[indicate complete contract name/ number, and any other identification]</i> Name of Purchaser: <i>[insert full name]</i> Address of Purchaser: <i>[insert street/city/country]</i> Reason(s) for suspension or termination: <i>[indicate main reason(s)]</i>	<i>[insert amount]</i>

<i>[insert year]</i>	<i>[insert amount and percentage]</i>	Contract Identification: <i>[indicate complete contract name/ number, and any other identification]</i> Name of Purchaser: <i>[insert full name]</i> Address of Purchaser: <i>[insert street/city/country]</i> Reason(s) for suspension or termination: <i>[indicate main reason(s)]</i>	<i>[insert amount]</i>
...	...	<i>[list all applicable contracts]</i>	...
b. Details of Contract(s) in which Performance Security called by an Purchaser(s) for reasons related to ESHS performance			
Year	Contract Identification		Total Contract Amount (current value, currency, exchange rate and INR equivalent)
<i>[insert year]</i>	Contract Identification: <i>[indicate complete contract name/ number, and any other identification]</i> Name of Purchaser: <i>[insert full name]</i> Address of Purchaser: <i>[insert street/city/country]</i> Reason(s) for calling of performance security: <i>[indicate main reason(s)]</i>		<i>[insert amount]</i>

Tenderer's Authorized Representative

Signature:

Date:

Company stamp:

Form FIN-3.3.1:**Financial Situation and Performance**

[Ref. ITT Sub-Clause 17.2 and Section III, Evaluation and Qualification Criteria, Sub-Clause 3.3.1 (ii)]

[The following table shall be filled in for the Tenderer]

Tender No.: HORC/HRIDC/PSC-01/2023

Tenderer's Name: _____

Page _____ of _____ pages

Financial data

(All amounts in Millions)

Type of Financial information in (currency)	Historic information for last three Financial Years, (amount in currency, currency, exchange rate*, INR equivalent)		
	Year 1: 2020-21	Year 2:2021-22	Year 3:2022-23
	Statement of Financial Position (Information from Balance Sheet)		
Total Assets (TA)			
Total Liabilities (TL)			
Total Equity/Net Worth (NW) = TA-TL			
Current Assets (CA)			
Current Liabilities (CL)			
Working Capital (WC)			
Total Revenue (TR)			
Profits Before Taxes (PBT)			

*Refer to Notes: Exchange Rate for Qualification Criteria, Section III, EQC.

Notes:

- (i) In case, the Financial Year is the same as the Calendar Year, the financial data for the year 2020,2021 and 2022 shall be furnished.

- (ii) *The Tenderer is not required to submit any document as documentary evidence along with the Tender Documents. All information furnished in this Form shall be certified by a Chartered Accountant/Company Auditor/Statutory Auditor.*
- (iii) *The Form duly certified by a Chartered Accountant/Company Auditor/Statutory Auditor shall also be signed by Tenderer's Authorized representative.*
- (iv) *The above documents shall reflect the financial situation of the legal entity or entities comprising the Tenderer and not the Tenderer's parent companies, subsidiaries, or affiliates.*
- (v) *In the event that the audited accounts for the latest concluded Financial Year are not available, the Tenderer shall furnish information pertaining to the last three financial years after ignoring the latest concluded financial year. In case, the Tenderer submits audited financial information for the last four or more years, only the figures for the latest three years shall be considered for evaluation.*
- (vi) *In case audited balance sheet of the last financial year is not available with the tenderer, he will declare the same vide item (p) prescribed in the Letter of Tender-Technical Part.*
- (vii) ***If the value of Net Worth is not submitted for any of the last three years, the Tender shall be considered nonresponsive and shall be summarily rejected.***

Tenderer's Authorized Representative

Signature:

Date:

Company stamp:

Chartered Accountant/Company Auditor/Statutory Auditor

Certified that the information furnished above is correct as per the audited balance sheets of the entity.

Signature:

Name:

Position:

Date:

Company:

Company stamp:

Membership No:

Address:

Contact No:

Email ID:

Form FIN-3.3.2

Deleted

Form FIN-3.3.3:**Sources of Finance for the Subject Contract (i.e. PSC-01)**

[Ref. ITT Sub-Clause 17.2 and Section III, Evaluation and Qualification Criteria, Sub-Clause 3.3.1 (i)]

[The following table shall be filled in for the Tenderer]

Tender No.: HARC/HRIDC/PSC-01 /2023

Tenderer's Name: _____

Page _____ of _____ pages

Tenderer should specify proposed sources of financing, such as liquid assets, unencumbered real assets, lines of credit, and other financial means, net of current contract commitments, available to meet the total construction cash flow demands of the subject contract **i.e. Package PSC-01.**

(All amounts in

Millions)

Financial Resources for Package PSC-01		
No.	Source of financing	Amount (INR equivalent)
1		
2		
3		
Total Sources of Finance for Package PSC-01		

- (i) *The Tenderer is not required to submit any document as documentary evidence along with the Tender Documents. All information furnished in this Form shall be certified by a Chartered Accountant/Company Auditor/Statutory Auditor.*
- (ii) *The Form duly certified by a Chartered Accountant/Company Auditor/Statutory Auditor shall also be signed by Tenderer's Authorized representative.*
- (iii) *The above documents shall reflect the financial situation of the legal entity or entities comprising the Tenderer and not the Tenderer's parent companies, subsidiaries, or affiliates.*

Tenderer's Authorized Representative

Signature:

Date:

Company stamp:

Chartered Accountant/Company Auditor/Statutory Auditor

Certified that the information furnished above is correct.

Signature:

Name:

Position:

Date:

Company:

Company stamp:

Membership No:

Address:

Contact No:

Email ID:

Form EXP-3.4.1

RDSO certifications of Concrete Sleeper Plants (CSPs) Plant/Production facility

[Ref. ITT Sub-Clause 17.2 and Section III, Evaluation and Qualification Criteria, Sub-Clause 3.4.1]

[The following table shall be filled in for the Tenderer]

Tender No.: HORC/HRIDC/PSC-01/2023

Tenderer's Name: _____

Page _____ of _____ pages

1. Details of Concrete Sleeper Plant

Name of Product to be Supplied			
Manufacturer/Supplier			
Address of Manufacturer/Supplier: Telephone/fax number E-mail:			
Authorised Representative of Manufacturer/Supplier			
<i>Details of Concrete Sleeper Plant</i>			
Concrete Sleeper Plant	Address	Year of RDSO Certification & validity	<i>Copy of RDSO Approval Certificate Attached (Yes/No)</i>
CSP 1			

Tenderer’s Authorized Representative

Signature:

Date:

Company stamp:

Note:

- (i) *The Tenderer shall submit copy of RDSO approval/certification for Concrete Sleeper Plants (CSPs) with their Tender clearly indicating the date of certification and production Capacity of the Plants. **Tender submitted without this documentary proof shall not be evaluated.***

Form EXP-3.4.2

Available Production Capacity

[Ref. ITT Sub-Clause 17.2 and Section III, Evaluation and Qualification Criteria, Sub-Clause 3.4.2]

[The following table shall be filled in for the Tenderer]

Tender No.: HORC/HRIDC/PSC-01/2023

Tenderer's Name: _____

Page _____ of _____ pages

1.Details of Production Facility available with the Tenderer

Name of Product to be Supplied			
Manufacturer/Supplier			
Address of Manufacturer/Supplier: Telephone/fax number E-mail:			
Authorised Representative of Manufacturer/Supplier			
<i>Details of Production Facility</i>			
Production Facility Concrete Sleeper Plant	Address	Year of Certification & validity	Capacity Per Year
CSP 1			
CSP 2			
CSP 3			
Total Capacity Per Year , (A)			

2.0 Current Contract Commitments /Supply in Progress

Tenderer should provide information on their current commitments on all contract that have been awarded, or for which a letter of intent or acceptance has been received, or for contracts approaching completion, but for which an unqualified, full completion certificate is yet to be issued.

Current Contract Commitments /Supply in Progress

S. No.	Name of Purchaser with telephone	Contract No. & Award Date	Total Quantity to be supplied (Nos.)	Quantity Supplied (Nos.)	Balance quantity to be supplied	Stipulated Period of completion	Remaining period of Supply completion
(1)	(2)	(3)	(4)	(5)	(6) = (4)-(5)	(7)	8
1.							
2.							
3.							
Total balance quantities to be supplied, (B)= Σ of quantities of column (6)							

Notes:

- (i) Where a supply is undertaken by a JV/Consortium, only that portion of the contract which is undertaken by the concerned applicant/member should be indicated and the remaining done by the other members of the JV/Consortium be excluded.
- (ii) The Tenderer is not required to submit any document as documentary evidence along with the Tender Documents. **All information furnished in this Form shall be certified by a Chartered Accountant/Company Auditor/Statutory Auditor.**

"Certified that current commitments on all the contracts that have been awarded or for which a letter of intent or acceptance has been received or for the supplies in progress or the supplies approaching completion, value of outstanding supply quantities have been indicated in the above table correctly. It is further certified that if later on the Purchaser discovers that information provided in the table is incorrect then the Purchaser will treat our Tender invalid and it will be liable for rejection"

3. Calculation of Available Production Capacity of Tenderer for 4 years

Description	Number of sleepers
A= Total Capacity per Year X 4	
B= Balance Total quantities to be supplied as calculated in table of item 2 above	
Available Production Capacity = (A) –(B)	

Tenderer's Authorized Representative

Signature:

Date:

Company stamp:

Note:

The Tender must submit RDSO approval/certification for each of the Production Facility mentioned in Para 1 above.

Tender Security

The amount for Tender Security will only be paid online by eligible Tenderers on eProcurement Portal of Government of Haryana (<https://etenders.hry.nic.in>).

OR

Tender Security can be submitted in the form of unconditional and irrevocable Bank Guarantee⁴ in INR or the equivalent amount in a freely convertible currency from the banks specified in Sub-Clause ITT 19.3, Section II- TDS using the Tender Security Form given below.

Note: The rates of exchange for computing INR equivalent shall be the reference rate prevailing twenty-eight (28) days prior to the deadline of Tender submission. Exchange rates shall be taken from the sources specified in Note No. 1 (iii) given under Sub-Clause 3.4, Section III, EQC.

⁴ Refer Sub-Clause ITT 1.3 H and Sub-Clause 19.3, Section II, TDS for submission of the Tender Security in the form of BG. Option of Exemption from payment of EMD mentioned in the module of eProcurement portal is only for exemption of online payment of Tender Security to the Tenderers who wish to submit Tender Security in the form of Bank Guarantee.

Tender Security Form of Demand Guarantee

Beneficiary:

Haryana Rail Infrastructure Development Corporation Limited,
Plot No 143, 5th Floor, Railtel Tower,
Sector-44, Gurugram, Haryana-122003

Tender No: HORC/HRIDC/PSC-01/2023**Date:** _____ *[Insert date of issue of Demand Guarantee]***TENDER SECURITY GUARANTEE No.:** _____**Guarantor:** *[Insert name and address of place of issue, unless indicated in the letterhead]*

We have been informed that _____ (hereinafter called "the Applicant") has submitted or will submit to the Beneficiary its Tender (hereinafter called "the Tender") for the execution of **“PSC-01: Manufacture and Supply of Pre-stressed Mono Block Concrete Line Sleepers conforming to RDSO Drg. No. T-8746 in connection with laying of New BG Double Railway Line from Prithla to New Harsana Kalan of Haryana Orbital Rail Corridor (HORC) Project”**.

Furthermore, we understand that, according to the Beneficiary’s conditions, Tenders must be supported by a Tender guarantee.

At the request of the Applicant, we, as Guarantor, hereby irrevocably undertake to pay the Beneficiary any sum or sums not exceeding in total an amount of _____ (_____) upon receipt by us of the Beneficiary’s complying demand, supported by the Beneficiary’s statement, whether in the demand itself or a separate signed document accompanying or identifying the demand, stating that either the Applicant:

- (a) has withdrawn its Tender during the period of Tender validity set forth in the Applicant’s Letter of Tender (“the Tender Validity Period”), or any extension thereto provided by the Applicant; or
- (b) having been notified of the acceptance of its Tender by the Beneficiary during the Tender Validity Period or any extension thereto provided by the Applicant, (i) has failed to execute the contract agreement, or (ii) has failed to furnish the Performance Security in accordance with the Instructions to Tenderers (“ITT”) of the Beneficiary’s Tender Document.

This guarantee will expire: (a) if the Applicant is the successful Tenderer, upon our receipt of copies of the contract agreement signed by the Applicant and the Performance Security issued to the Beneficiary in relation to such contract agreement; or (b) if the Applicant is not the successful Tenderer, upon the earlier of (i) our receipt of a copy of the Beneficiary's notification to the Applicant of the results of the Tendering process; or (ii) twenty-eight days after the end of the Tender Validity Period.

Consequently, any demand for payment under this guarantee must be received by us at the office indicated above on or before that date.

This guarantee is subject to the Uniform Rules for Demand Guarantees (URDG) 2010 Revision, ICC Publication No. 758.

[signature(s)]

Tender-Securing Declaration

Deleted

Manufacturer's Authorization

Deleted

Country of Origin Declaration Form**Name of Tenderer:****Tender No.:**

S. No.	Description	Country of Origin

Tenderer's Authorized Representative

Signature:

Date:

Company stamp:

Letter of Tender – Financial Part

INSTRUCTIONS TO TENDERERS: DELETE THIS BOX ONCE YOU HAVE COMPLETED THE DOCUMENT

The Tenderer must prepare this Letter of Tender on stationery with its letterhead clearly showing the Tenderer's complete name and business address.

Note: All italicized text is to help Tenderers in preparing this form.

Date of this Tender submission: *[insert date (as day, month and year) of Tender submission]*

Tender No.: HORC/HRIDC/PSC-01/2023

To:

GM/IP&IT,

Haryana Rail Infrastructure Development Corporation Limited (HRIDC),
Plot no.143, 5th floor,
Railtel Tower, Sector-44
Gurugram – 122003

Tel: +91 7011056770

We, the undersigned, hereby submit the second part of our Tender, the Tender Price and Price Schedule. This accompanies the Letter of Tender – Technical Part.

In submitting our Tender, we declare that:

- (a) **Tender Validity Period:** Our Tender shall be valid for the period specified in TDS 18.1 (as amended, if applicable) after the date fixed for the Tender submission deadline specified in TDS 22.1 (as amended, if applicable), and it shall remain binding upon us and may be accepted at any time before the expiration of that period;
- (b) ****Tender Price:** The total price of our Tender is: *[insert the total price of the Tender in words and figures in INR]*;
- (c) **Commissions, Gratuities, Fees:** We have paid, or will pay the following commissions, gratuities, or fees with respect to the Tendering process or execution of the Contract: *[insert complete name of each Recipient, its full address, the reason for*

which each commission or gratuity was paid and the amount and currency of each such commission or gratuity]

Name of Recipient	Address	Reason	Amount

(If none has been paid or is to be paid, indicate “none.”)

Name of the Tenderer: *[insert complete name of the Tenderer]*

Name of the person duly authorized to sign the Tender on behalf of the Tenderer:

**[insert complete name of person duly authorized to sign the Tender]*

Title of the person signing the Tender: *[insert complete title of the person signing the Tender]*

Signature of the person named above: *[insert signature of person whose name and capacity are shown above]*

Date signed *[insert date of signing]* **day of** *[insert month]*, *[insert year]*

*: Person signing the Tender shall have the power of attorney given by the Tenderer. The power of attorney shall be attached with the Letter of Tender.

Appendix A to Financial Part: Schedule of Adjustment Data

1. Price adjustment

- 1.1 The amounts payable to the Supplier for Works shall be adjusted in accordance with the provisions of this Clause 1.0, Sub-Clause 13.7 of GCC and Sub-Clause 13.7, Specific Provision, Part B, Section IX-PCC.
- 1.2 The Contract price shall include all duties (including Customs duties), taxes including Goods and Services Taxes (GST), insurances, transportation cost to the final destination (Project site), Inspection charges, Freight Charges, royalties, fees, cess, octroi/Entry tax, other levies payable by the Supplier under the Contract, or for any other cause, as of the date 28 days prior to the deadline for submission of Tenders shall be included in the rates, prices and the total Tender Price submitted by the Tenderer.
- 1.3 The prices charged for the Goods supplied and the related Services performed shall be adjustable.

Price Adjustment Formula

The following method shall be used to calculate the price adjustment:

$$P_1 = (P_0 / 100) (10 + 23 I_1 / I_0 + 11 L_1 / L_0 + 21 S_1 / S_0 + 26 C_1 / C_0 + 9 W_1 / W_0)$$

Where,

P₁	Updated Rate of sleeper
P₀	Accepted Rate of sleeper
I₁	WPI for Pig Iron during production Month as per Economic Advisor, Ministry of Industry web site http:// eaindustry.nic.in
I₀	WPI of Pig Iron for one month before tender opening month as per Economic Advisor, Ministry of Industry Web site http://eaindustry.nic.in
L₁	All India Consumer Price Index of Industrial Labour during production Month, as per Labour Bureau, Ministry of Labour web site http://labourbureau.nic.in
L₀	All India Consumer Price Index for Industrial Labour for one month before tender opening month as per Labour Bureau, Ministry of Labour web site http://labourbureau.nic.in

S₁	WPI for alloy steel wire rods during Production Month as per Economic Advisor, Ministry of Industry web site http:// eaindustry.nic. in
So	WPI for alloy steel wire rods for one month before tender opening month as per Economic Advisor, Ministry of Industry web site http:// eaindustry.nic. in
C₁	WPI for “Ordinary Portland Cement” during production month as per Economic Adviser, Ministry of Industry website http://eaindustry.nic.in/
Co	WPI for “Ordinary Portland Cement” one month before tender opening month as per Economic Adviser, Ministry of Industry website http://eaindustry.nic.in/
W₁	WPI for all commodities during production Month as per Economic Advisor, Ministry of Industry web site http:// eaindustry.nic. in
Wo	WPI for all commodities for one month before tender opening month, as per Economic Advisor, Ministry of Industry web site http:// eaindustry.nic. in

1.4 In order to avoid blockage of funds till final escalation is worked out and paid on the basis of indices for the month of production, the accepted price will be updated every six months as per the above formula for escalation. First updating shall be done on the basis of indices for the month of acceptance of tender as soon as confirmed indices for the month of acceptance are available. Payment for the supplies made shall be done at the latest updated price.

1.5 No price adjustment shall be payable on the portion of the Contract Price paid to the Supplier as advance payment.

Table A. Foreign Currency (FC)

Not applicable as Tenderers are required to quote rates and prices only in INR.

Table B. Summary of Payment Currencies

For [insert name of Works]

Name of Payment Currency	A	B	C	D
	Amount of Currency	Rate of Exchange (local currency per unit of foreign)	Local Currency Equivalent $C = A \times B$	Percentage of Net Tender Price (NTP) $\frac{100 \times C}{NTP}$
Local currency <u>(INR)</u>		1.00		
Foreign Currency #1 _____				
Foreign Currency #2 _____				
Foreign Currency #3 _____				
Total Tender Price				100.00

Note: The Tenderer is required to propose and submit the schedules given in tables above as part of the Tender. The rates of exchange shall be the reference rate twenty-eight (28) days prior to the deadline for submission of Tenders published by the Reserve Bank of India (RBI) on its website <https://www.rbi.org.in>. In case the exchange rate of particular currency on given date is not available on RBI web site, it will be as per the web site <https://www.fbil.org.in> of Financial Benchmark India Private Limited (FBIL). In the case, where a Tenderer is required to convert a monetary amount from a currency other than those currencies for which the RBI/FBIL reference rate is not published, the INR equivalent shall be worked out using the rate of exchange as published by the central bank of the country issuing the said currency. In case the exchange rate of that currency is not directly available in INR on the website of the central bank of the country issuing the said currency then the currency will be first converted to USD as per that web site and then converted from USD to INR as Per RBI or FBIL reference rates.

Appendix B to Financial part: Bill of Quantities

1. Preamble

- 1.1. The Bill of Quantities shall be read in conjunction with the Instructions to Tenderers, the General Conditions, the Special Conditions and the Supply Requirements and the Addenda/Corrigenda (if any).
- 1.2. The quantities given in the Bills of Quantities are estimated and provisional and are given to provide a common basis for tendering. The basis of payment will be the actual quantities ordered and supply carried out, as measured by the Supplier and verified by the Engineer and valued at the rates and prices in the priced Bill of Quantities, where applicable, and otherwise at such rates and prices as the Engineer may fix within the terms of the Contract.
- 1.3. The supply of sleepers in accordance with the terms and conditions of this contract shall be at the accepted unit rate, subject to price adjustment in terms of SCC Para 15.1. In addition to the accepted rate the Supplier will also retain GST input credits available on input materials on the date of opening of the tender. GST input credit shall be covered under Clause 15.1.3 of Section IX-Special Conditions of Contract..”
- 1.4. The **quoted** rate shall be inclusive of the cost of all labour and all-inclusive cost of input materials (including cost of input freight if any) like HTS Wire, Inserts, Cement and coarse and fine aggregates, Fuel and Power etc., GST, including all handling charge and duties thereon.
 - 1.4.1. The **quoted** rate would also include the cost of transportation of finished sleepers to loading point and loading into the road vehicles in accordance with the approved drawing including the cost of handling involved in the process. The Cost of wooden packings as per drawings will be borne by the Supplier.
 - 1.4.2. The **quoted** rate would also include equated freight charge and other incidental charges for delivery up to consignee destination and unloading and stacking at destination (Approximate locations and approximate quantities of delivery have been given in Schedule of Requirement in Section VII-Schedule of Requirements). The Cost of wooden packings for stacking at the site of unloading as per drawings will be borne by the Supplier.
 - 1.4.3. The quoted rates shall be exclusive of inspection charges to be charged by inspecting Railway which will be paid by the HRIDC directly to inspecting Railway. However, third party inspection of all input materials required as per IRS Specification T-39 shall be arranged by the tenderer on the advice of inspecting Railway and inspection charges to be borne by the tenderer.
- 1.5. The supply of sleepers in accordance with the terms and conditions of this contract shall be at the accepted unit rate, subject to price variation in terms of Appendix A to

Financial Part: Schedule of Adjustment Data.

- 1.6. Statutory variation in GST will be applicable. The purchaser will, however, not be responsible for the reimbursement of any Taxes/Levies paid by the Supplier under misapprehension of law.
- 1.7. In the event of 'GST' input credit being extended by the Government of India to more items than those already covered on date of tender opening, the firm should advise the purchaser about the additional benefits accrued or any variation thereof, through a letter containing the following certificate.
- “We hereby declare that additional set-offs/Input tax credit to the tune of Rs..... has accrued and accordingly the same is being passed on to the purchaser and to that effect the payable amount may be adjusted.”
- 1.8. The Payment shall be made as per Clause 16 [Terms of Payment] of the General Conditions and Special Conditions of Contract.
- 1.9. The Purchaser shall make interim payments to the Supplier in accordance with the provisions of Sub-Clause 16.1 [Terms of Payment] of the General Conditions and Special Conditions of Contract, as certified by the Engineer.
- 1.10. The Supplier shall base its claim for interim payment in accordance with Sub-Clause 16.1 [Terms of Payment] of the General Conditions and Special Conditions for supplies completed till the end of the month, supported with documents and updated programme in accordance with the Supply Requirements.
- 1.11. Format for the Supplier's application for payment shall be agreed between the Engineer and the Supplier.
- 1.12. All necessary supplementary details to support delivery at destination, Railways test reports, input materials test reports, consignee receipt certificate etc. shall accompany an application for payment to be substantiated and certified by the Engineer and submitted to the Purchaser.
- 1.13. The Contract will remain current and valid for a stipulated delivery period including extensions if any, with effect from the date of acceptance of tender/counter offer, as the case may be. The Purchaser also has the right to defer deliveries (i.e. slow down supplies). The purchaser shall also have the right to enhance delivery period upto 12 months on the same rates, terms and conditions at its sole discretion.

2.0 Bill of Quantities

<u>Bill of Quantities</u>					
NAME OF WORK	PSC-01: Manufacture and Supply of Pre-stressed Mono Block Concrete Line Sleepers conforming to RDSO Drg. No. T-8746 in connection with laying of New BG Double Railway Line from Prithla to New Harsana Kalan of Haryana Orbital Rail Corridor (HORC) Project.				
Item No.	Item of Work	Unit	Quantity	Rate (Rs)	Amount (Rs)
1	Manufacture and Supply of Pre-stressed Mono Block Concrete Line Sleepers conforming to RDSO Drg. No. T-8746 in connection with laying of New BG Double Railway Line from Prithla to New Harsana Kalan of Haryana Orbital Rail Corridor (HORC) Project.	Nos.	5,27,400	4015.54	2,11,77,95,796.00
Total Estimated Amount (INR)					2,11,77,95,796.00

Bill of Quantities

(Please refer Bill of Quantities uploaded on eProcurement portal for quoting percentage rate)

Validate		Print		Help		Item Rate BoQ	
Tender Inviting Authority: Haryana Rail Infrastructure Development Corporation Ltd							
Name of Work: PSC-01: Manufacture and Supply of Pre-stressed Mono Block Concrete Line Sleepers conforming to RDSO Drg. No. T-8746 in connection with laying of New BG Double Railway Line from Prithla to New Harsana Kalan of Haryana Orbital Rail Corridor (HORC) Project.							
Contract No: HORC/HRIDC/PSC-01/2023							
Name of the Bidder/ Bidding Firm / Company :							
Bill of Quantities (This BOQ template must not be modified/replaced by the bidder and the same should be uploaded after filling the relevant columns. Bidder is liable to be rejected for this tender. Tenderers are allowed to enter the Tenderer Name and Values)							
NUMBER #	TEXT #	NUMBER	TEXT	NUMBER #	TEXT #		
Sl. No.	Item Description	Estimated Rate in Rs. P	Excess to be entered by the Bidder	TOTAL AMOUNT With Taxes	TOTAL AMOUNT In Words		
1	Manufacture and Supply of Pre-stressed Mono Block Concrete Line Sleepers conforming to RDSO Drg. No. T-8746 in connection with laying of New BG Double Railway Line from Prithla to New Harsana Kalan of Haryana Orbital Rail Corridor (HORC) Project.		Select	-	INR Zero Only		
Total in Figures				-	INR Zero Only		
Quoted Rate in Words				INR Zero Only			

 *Tenderer is only required to fill the information in the boxes highlighted with cyan colour in Price Schedule (Excel sheet)

Section V - Eligible Countries**Eligibility for the Provision of Goods, Works and Non-Consulting Services in
Bank-Financed Procurement**

In reference to ITT 4.8 and ITT 5.1, for the information of the Tenderers, at the present time firms, goods and services from the following countries are excluded from this Tender process:

Under ITT 4.8(a) and ITT 5.1: ***“none”***.

Under ITT 4.8(b) and ITT 5.1: ***“none”***

Page intentionally left Blank

Section VI – Prohibited Practices

1. The Bank requires that the Recipient (and all other beneficiaries of the Bank financing), as well as tenderers, suppliers, contractors, concessionaires and consultants under Bank-financed contracts for the Project, observe the highest standard of transparency and integrity during the procurement, execution and implementation of such contracts.
2. Definitions. In pursuance of this policy, the Bank defines the terms set forth below as Prohibited Practices:
 - (a) “**Coercive practice**” means impairing or harming or threatening to impair or harm, directly or indirectly, any party or the property of a party to influence improperly the actions of a party.
 - (b) “**Collusive practice**” means an arrangement between two or more parties designed to achieve an improper purpose, including to influence improperly the actions of another party.
 - (c) “**Corrupt practice**” means the offering, giving, receiving or soliciting, directly or indirectly, of anything of value to influence improperly the actions of another party.
 - (d) “**Fraudulent practice**” means any act or omission, including a misrepresentation, that knowingly or recklessly misleads or attempts to mislead, a party to obtain a financial or other benefit or to avoid an obligation.
 - (e) “**Misuse of resources**” means improper use of the Bank’s resources, carried out either intentionally or through reckless disregard.
 - (f) “**Obstructive practice**” means any of the following practices: (i) deliberately destroying, falsifying, altering or concealing of evidence material to a Bank investigation; (ii) making false statements to investigators in order to materially impede a Bank investigation into allegations of a Prohibited Practice; (iii) failing to comply with requests to provide information, documents or records in connection with a Bank investigation; (iv) threatening, harassing or intimidating any party to prevent it from disclosing its knowledge of matters relevant to a Bank investigation or from pursuing the investigation; or (v) materially impeding the exercise of the Bank’s contractual rights of audit or inspection or access to information.
 - (g) “**Theft**” means the misappropriation of property belonging to another party.
3. Any occurrence, or suspected occurrence, of a Prohibited Practice in the procurement, award or implementation of a Bank-financed contract is dealt with in accordance with the provisions of the Bank’s Policy on Prohibited Practices. Suppliers, contractors, service providers and consultants selected pursuant to the provisions of Section II and concessionaires selected pursuant to paragraph 14.3 of the Bank’s Procurement Instructions for Recipients, as well as the Recipient shall fully cooperate with the Bank (or a co-financier undertaking an investigation pursuant to paragraph 6.1 of the Bank’s Procurement Instructions for Recipients) in any investigation into an alleged Prohibited Practice to be carried out pursuant to the Policy on Prohibited Practices, and permit the Bank or its representative (including such co-financier) to inspect such of their accounts and records

as may be relevant for such investigation and to have such records and accounts audited by the auditors appointed by the Bank.

4. Provisions to this effect are included in the Legal Agreements and the procurement contracts with such entities.
5. If the Project is financed by a sovereign-backed loan, the Bank (or, where relevant, a co-financier having undertaken an investigation pursuant to paragraph 6.1 of the Bank's Procurement Instructions for Recipients):
 - (a) may take any of the following additional actions in connection with a Prohibited Practice under the Project:
 - (i) reject a proposal for award if it determines that the tenderer recommended for award, or any of its personnel, or its agents, or its subconsultants, subcontractors, service providers, suppliers or their employees, has, directly or indirectly, engaged in a prohibited practice in competing for the contract in question; and
 - (ii) cancel the undisbursed portion of the loan allocated to a contract (and require reimbursement of the disbursed portion of the loan allocated to the contract) if it determines at any time that representatives of the Recipient or of a recipient of any part of the proceeds of the loan engaged in a prohibited practice during the procurement, administration or implementation of the contract in question; and
 - (b) requires that a clause be included in tender documents and in contracts financed by the Bank loan, requiring tenderers, suppliers and contractors and their subcontractors, agents, personnel, consultants, service providers or suppliers, to permit the Bank (and a co-financier undertaking an investigation pursuant to paragraph 6.1 of the Bank's Procurement Instructions for Recipients) to inspect all accounts, records and other documents relating to the submission of tenders and contract performance, and to have them audited by auditors appointed by the Bank.

Summary

Specific Procurement Notice (SPN)

PART 1 – TENDERING PROCEDURES

- Section I - Instructions to Tenderers (ITT)
- Section II - Tender Data Sheet (TDS)
- Section III - Evaluation and Qualification Criteria
- Section IV - Tender Forms
- Section V - Eligible Countries
- Section VI - Prohibited Practices

<h4>PART 2 – SUPPLY REQUIREMENTS</h4>
--

- | |
|--|
| Section VII – Schedule of Requirements |
|--|

PART 3 – CONDITIONS OF CONTRACT AND CONTRACT FORMS

- Section VIII - General Conditions of Contract (GCC)
- Section IX - Special Conditions of Contract (SCC)
- Section X - Contract Forms

Page Intentionally Left Blank

PART 2 – Supply Requirements

Section VII - Schedule of Requirements

Contents

- 1. List of Goods and Delivery Schedule**
- 2. Dispatch**
- 3. Technical Specifications**
- 4. Drawings**
- 5. Inspections and Tests**
- 6. Modification to Design**

1. List of Goods and Delivery Schedule

The supply of sleepers shall commence within one months from the date of unconditional acceptance of offer/issue of acceptance. Thereafter, the ordered quantity shall be supplied during the delivery period (D.P) of 1460 days as detailed below:

S. No.	Description of Goods	Proposed Destination	Approx Qty	Unit	Tentative Delivery Month
1	Manufacture and Supply of Pre-stressed Mono Block Concrete Line Sleepers conforming to RDSO Drg. No. T-8746 in connection with laying of New BG Double Railway Line from Prithla to New Harsana Kalan of Haryana Orbital Rail Corridor (HORC) Project.	MSIL/Manesar	12500	Nos.	Jan/Feb-24
2		Manesar	18000	Nos.	May-24
3		Manesar	12400	Nos.	Jul-24
4		Patli	8100	Nos.	Sep-24
5		Sultanpur	7000	Nos.	Nov-24
6		New Patli	32900	Nos.	Mar-25
7		Pachgaon	15500	Nos.	May-25
8		Chandla Dungerwas	11000	Nos.	Jul-25
9		Dhulawat	11000	Nos.	Sep-25
10		Chandla Dungerwas	11500	Nos.	Jan-26
11		Mandothi Jn.	7000	Nos.	Jan-26
12		Dhulawat	10300	Nos.	Jan-26
13		Dhulawat	22900	Nos.	Mar-26
14		IMT Sohna	40600	Nos.	Apr-26
15		Silani	31600	Nos.	Jul-26
16		Prithala Jn.	27900	Nos.	Sep-26
17		Badsa	29900	Nos.	Nov-26
18		Deverkhana	20000	Nos.	Dec-26
19		Badli	35000	Nos.	Feb-27
20		Mandothi Jn.	30900	Nos.	Apr-27
21		Kharkhoda	31400	Nos.	Jun-27
22		Asaudah	3900	Nos.	Aug-27
23		New Asaudah	14000	Nos.	Aug-27
24		Jasur Kheri	23400	Nos.	Oct-27
25		New Harsana Kalan	26300	Nos.	Nov-27
26		Tarakpur	32400	Nos.	Dec-27
Total			527400	Nos.	

2. Dispatch

- 2.1. The Consignee to receive material will be Senior Track Expert General Consultant/ HORC or any other personnel nominated by the Engineer. The delivery Location will be along the HORC corridor from Prithala to Harsana Kalan as per Delivery Schedule and instructions of Consignee.
- 2.2. The consignee instructions and booking orders will be given by the Engineer or its authorised official.
- 2.3. The Supplier shall be responsible for delivery of sleepers to consignee/destination indicated by the Purchaser during the execution of contract. Unloading and stacking at Consignee's destination will have to be arranged by the Supplier ..
- 2.4. The Purchaser however has the right to slow down the supplies (deferred delivery), and accordingly have the right to enhance delivery period unilaterally up to 12 months on the same rates, terms and conditions at its sole discretion.

Notwithstanding the specified schedule of delivery, actual supplies will be regulated by the purchaser as per its actual requirement. The specified supply schedule can however be altered by slowing down the rate of production by the purchaser by giving 3 months' notice to supplier. In case the supplies are slowed down, the delivery period will be extended accordingly. Enhancement of the supplies in the specified supply schedule will however be done with the mutual consent. Failure to make supplies as per the specified delivery schedule fixed in advance will attract liquidated damages as per Clause 27 of General Conditions of Contract/Special Conditions of Contract.

3. Technical Specifications

3.1 Technical Specifications. The Goods and Related Services shall comply with following Technical Specifications and Standards:

Name of Goods or Related Service	Technical Specifications and Standards
Pre-stressed Mono-Block Concrete line Sleepers confirming to RDSO specification RT-8746	Indian Railway Standard Specification No T-39(6 the revision, March 2021 or latest as on date of tender opening) Current specifications has been attached as Annexure-1
	Schedule of Technical Requirement (STR) for PSC Sleepers-June 2023 or latest as on date of tender opening Current STR has been attached as Annexure-2

3.2 Deleted

3.3 Raw Material, Machinery and Plant

- 3.3.1 The responsibility for procurement of all raw materials, machinery and plants required for the manufacture of goods shall rest entirely with the supplier.
- 3.3.2 53-S grade Ordinary Portland Cement confirming to BIS Specifications IS:269:2015 as amended up to date of tender opening shall be procured by the Supplier at his own from the from the Cement manufacturers having valid Bureau of Indian Standards license for manufacturing of 53-S grade Ordinary Portland Cement
- 3.3.3 HTS Wires shall be procured from the firms who are approved for manufacture of HTS Wire by Bureau of Indian Standards and possess a current valid BIS License for manufacture of the particular type of wire i.e. 3 x 3 mm strand, 7/7.5 mm plain wire or 9.5 mm dia strand as the case may be.
- 3.3.4 SGCI Inserts shall be procured from the firms, who are approved by RDSO for the manufacture of SGCI inserts and whose approval is current and valid. SGCI Inserts can also be procured from ISO certified firms as per guidelines issued vide RDSO's letter No. QA/CT/INSP/CI/Policy dated 25.08.2008.
- 3.3.5 Aggregates shall be procured by the Supplier from the sources approved at the time of approval of concrete mix design. If crushed sand is being used as fine aggregate in design mix concrete, then it should not be by-product of any other manufacturing process and should be in conformity to the provisions provided for crushed sand in IRS-T-39.
- 3.3.6 The cement content in the concrete mix shall not be more than 450 Kg/cum. This may necessitate use of plasticizer, which shall be procured by Supplier as per requirements laid in IRS-T-39. Quoted rate shall be inclusive of cost of plasticizer/admixture.

4. Drawings

This Tender Document includes the following drawings.

S. No.	Drawing No.	Description
1	Pre-stressed Mono-Block Concrete line Sleepers confirming to RDSO specification RT-8746	As per Indian Railway Standard Specification No T-39 (6 th revision, March 2021 or latest as on date of tender opening) and Schedule of Technical Requirement (STR) for PSC Sleepers-June 2023 or latest as on date of tender opening.

Note* A copy of relevant specification and drawing can be obtained on payment by the Tenderers from the Director General (Track), RDSO, Manak Nagar, Lucknow.

5. Inspections and Tests

- 5.1 Inspection of finished sleepers will be carried out by the Railway, in whose jurisdiction CSP of Supplier situated, at Supplier's premises as per procedure and frequency decided by the HRIDC/Railway. The inspection charges for inspection of sleepers by Railway/RDSO shall be borne by HRIDC. Inspection charges for all input materials like SGCI inserts etc. by RITES or any other third party inspection as per advise of Engineer/Railway/HRIDC or as per IRS Specification T-39 shall be borne by the Supplier.
- 5.2 Necessary coordination with the nominated inspecting staff at the factory will have to be done by the Supplier to facilitate prescribed inspection.
- 5.3 The Supplier shall be required to install and operate all necessary testing equipment required for testing the sleepers, test cubes, briskets etc. as stipulated in the IRS Specification for pre-stressed concrete sleepers (Pretension type). The testing equipment for the same must be available at the factory site. In addition, the Supplier shall arrange at his own cost for any further tests on materials, as may be indicated by the Engineer/Inspecting Officer, to be carried out at recognized Material Testing Centers/Institutes during the progress of manufacture of sleepers; even though, Test Certificates for such materials are available.
- 5.4 The passed sleepers, for which inspection certificates have duly been obtained, only shall be allowed to be taken for loading in road vehicles. Any damage to the sleepers in the process of loading in vehicles or carrying to the loading sites from the Supplier's premises shall be to Supplier's account.
- 5.5 Deleted
- 5.6 The testing of PSC line sleepers and their subsequent acceptance should be in accordance with the Standard Specifications of PSC line sleepers (IRS T-39) as amended up to date.
- 5.7 The supplier of PSC sleepers shall ensure that the necessary checks on supply of raw material e.g. Cement, aggregate, HTS wire, SGCI insert, as well as plants, machinery, equipments, instruments such as moulds, weigh-batching plant, stressing system, mixing & vibration system, steam curing system, de-moulding and de-tensioning, water curing, product inspection and lab testing, sleeper testing and dispatch etc. are being done as per the checklists issued by Railways Board/ RDSO from time to time and record of same shall be maintained.
- 5.7.1 Compliance to provisions of STR (Schedule of Technical Requirement):
The production of PSC sleepers against this tender shall be permitted only when the Concrete Sleeper Plant has complied all the provisions of STR.
- 5.7.2 Temporary suspension of production:
During course of execution, the production of the concrete sleepers may be temporarily suspended by Engineer on the advice of its inspecting officials or RDSO in serious cases of non-adherence to Specifications/Schedule of Technical Requirement or large scale rejection of

sleeper (>2%) or premature failure of sleepers in track. Engineer may order for temporary suspension of the production in above cases and direct the manufacturer to identify the defects in the manufacturing process and rectify the same within a reasonable period. Production will be resumed once the manufacturer identifies and removes the defects and same is verified by the Engineer and/or RDSO as the case may be. While allowing resumption of production, Engineer may also order for higher scale of testing, till quality of production is stabilized in terms of provisions of IRS-T-39.

- 5.7.3 The plants, which have not done any production for past more than one year (reckoning from issue of LOA), will be permitted to resume production only after re-validation/certification of plant by RDSO.
- 5.7.4 In cases, where contract of a CSP under previous contract, had to be cancelled/terminated on account of large scale rejection(>2%)/quality issues, the production will be allowed to be resumed only after re-validation/certification of plant by RDSO and initial 10,000 sleepers will be tested and passed by RDSO.
- 5.8 Sleepers used for tests, including abrasion test, and found as per specifications and drawings shall be paid for by the Purchaser at accepted rates. Such sleepers paid for shall remain the property of the Purchaser and will be disposed of in the manner prescribed by the Purchaser from time to time.
- 5.9 The rejected sleepers shall be permanently damaged by the Supplier so as to make them unusable in addition to the provisions provided in “Indian Railway specification for pre-tensioned prestressed concrete sleepers (serial no. T-39)”. A certification that all rejected sleepers of previous batches have been permanently damaged and marked as per drawing, will be given by manufacturer before offering the next batch of fresh sleepers for inspection.
- 5.10 Regular inspection of SGCI inserts will be done by M/s RITES Ltd. or any other nominated agency by Engineer at manufacturer’s premises. Inspection charges & GST as applicable towards the inspection charges by RITES/Nominated Inspection agency will be borne by Supplier CSPs. Besides regular inspection by RITES/Nominated inspection agency, HRIDC/Nominated Railway officials will also conduct the inspections prescribed in Railway Board’s letter no. 98/TK-II/22/11/17/Pt. Policy, dtd. 11.08.2003.
- 5.11 Regular inspection of HTS wire will be done by Inspecting authorities nominated by Engineer at manufacturer’s premises in accordance with IS: 6006. In addition to this, periodical test checks by nominated inspecting officer to be stipulated by the Inspecting Railway shall also be carried out. Apart from Railways necessary inspection shall also be carried out by HRIDC/General Consultant.
- 5.12 CSPs will ensure procurement of 53-S Grade Cement to requisite specification from BIS Licensee manufacturers along with their own Manufacturers Test Certificate with each consignment. In addition to this, periodical test checks by nominated Railway officer to be stipulated by the Inspecting Railway/Engineer and shall also be carried out.

6. Modification to Design

In case purchaser, at any stage, during the currency of the contract, decide to make minor modifications to the design of PSC Sleeper, the supplier shall modify the moulds, manufacturing process, etc. to suit such minor modifications. The cost of such modifications will be negotiated and mutually settled and will be paid by the purchaser.

Annexure 1

To Part 2 Supply Requirements

**INDIAN RAILWAY
STANDARD SPECIFICATION**

**FOR PRE-TENSIONED PRESTRESSED CONCRETE SLEEPERS
FOR
BROAD GAUGE, METRE GAUGE AND NARROW GAUGE
SERIAL NO. T-39**

(SIXTH REVISION – MARCH 2021)

**GOVERNMENT OF INDIA
MINISTRY OF RAILWAYS
(RAILWAY BOARD)**

**INDIAN RAILWAY
STANDARD SPECIFICATION
FOR PRE-TENSIONED PRESTRESSED CONCRETE SLEEPERS
FOR
BROAD GAUGE, METRE GAUGE AND NARROW GAUGE**

**SERIAL NO. T-39
(SIXTH REVISION – MARCH 2021)**

**RESEARCH DESIGNS AND STANDARDS ORGANISATION
LUCKNOW – 226011**

CONTENTS

<u>Para No.</u>	<u>Description</u>
0.	FOREWORD
1.	SCOPE
2.	GENERAL
3.	MATERIAL
3.1	High tensile steel
3.2	Cement
3.3	Admixture
3.4	Aggregate
3.5	Water
3.6	Concrete
3.7	SGCI Insert
4.	MANUFACTURE
4.1	Mould
4.2	Stretching of wire
4.3	Mixing & consolidation of concrete
4.4	De-tensioning
4.5	Curing
4.6	Supervision
4.7	Finish
4.8	Stacking
4.9	Lot
5.	INSPECTION AND TESTING
5.1	General
5.2	General
5.3	Checks and Test
5.3.1	General
5.3.1.1	Visual and dimensional check
5.3.2	Casting of cubes
5.3.3	Method of testing
5.3.4	Compressive strength of cube at transfer of prestress
5.3.5	Compressive strength of cube at 15 days
5.3.6	Modulus of rupture of beam at 15 days
5.3.7	Static bending strength of sleepers
5.3.7.1	Method of testing
5.3.7.2	Acceptance test
5.3.7.3	Acceptance of lot
5.3.7.4	Retest
5.3.7.5	Testing of PSC sleeper in Zonal Railways testing facility or at RDSO

5.3.8 Measurement of Electrical resistance
5.4 Competency certificate

6 STAMPING AND MARKING

7 LOADING AND DISPATCH

8 GUARANTEE

**INDIAN RAILWAY SPECIFICATION FOR
FOR PRE-TENSIONED PRESTRESSED CONCRETE SLEEPERS
(BROAD GAUGE, METRE GAUGE AND NARROW GAUGE)
SERIAL NO. T-39
(SIXTH REVISION – MARCH 2021)**

0. **FOREWORD**

- 0.1 This standard specification (First revision) was adopted by the Indian Railways in May 1985 after the draft was finalized by the Sub-committee of Track Standards Committee.
- 0.2 The last revision (Fifth Revision) was adopted by the Indian Railways in February 2016.
- 0.3 The present revision (Sixth Revision) has been taken up with a view to incorporate modifications found necessary as a result of use of the specification both by the manufacturer and user.
- 0.4 The significant modifications incorporated in this revision are as follows :-
- 0.4.1 All Correction slips /Corrigendum (Corrigendum no. 1 to 6) issued till date have been incorporated.
- 0.4.2 Guarantee Clause has been revised to make it applicable for all type of line sleepers plying on Indian Railways.
- 0.4.3 List of specifications (IS/IRS codes) needed for daily use and referred to in this specification has been updated in Annexure-VI.
- 0.4.4 Clause for acceptance of lot has been revised to make it applicable for all type of line sleepers plying on Indian Railways.
- 0.4.5 Annexure-I has been revised.
- 0.4.6 Annexure-IIB showing gauge to measure toe gap at rail seat with SGCI Insert to Drg. No. RT/6901 has been added.
- 0.4.7 Annexure-III has been revised to make it applicable for all type of line sleepers plying on Indian Railways.

1. SCOPE

- 1.0 This specification covers the manufacture and supply of pre-tensioned pre-stressed concrete sleepers for broad gauge, metre gauge and narrow gauge. For production of PSC sleepers through long line method, some of the provisions of this Specification may not be implementable. In such cases, manufacturer shall approach RDSO for specific dispensations, wherever required and these dispensations will be considered by Track and Quality Assurance Directorate of RDSO.

2. GENERAL

- 2.1 The manufacture of sleepers shall be to the Purchaser's drawing or to drawings approved by the Purchaser and the production shall commence with the prior approval of the Inspecting Officer. Any subsequent change in material or production technique shall require prior approval of Inspecting Officer.
- 2.2 The reference to IRS specifications and drawings in this specification relates to the latest version of these standards as amended from time to time. The provisions of this specification shall override the corresponding provisions of IS: Specifications. Any special requirements given in the drawings of the sleepers will override the relevant provisions of the specification. Annexure-VI shows the list of specifications required for manufacturing of sleepers.

3. MATERIALS

3.1 High Tensile Steel

- 3.1.1 High tensile steel in the form of plain wire or strand shall conform to IS: 1785 Part-I and IS: 6006. It shall be procured only from BIS approved manufacturers who shall furnish the proof of approval by BIS with the first consignment during the currency of approval and for each fresh approval. Each consignment of high tensile steel must be accompanied by a test certificate showing the serial no. of coils. Each coil shall carry a tag in accordance with the IS specifications mentioned above. In addition to the normal tests stipulated in the IS specifications for every consignment, results of "relaxation test" shall also be furnished once in six months. In case of change of source the first test certificate shall include "relaxation test" results also.

The steel shall be used for production only after ascertaining that it meets the provisions of relevant specifications.

- 3.1.2 Whenever directed by the Inspecting Officer, the manufacturer shall get the steel in stock tested at his own cost.

3.2 **Cement**

- 3.2.1 Cement shall be OPC 53-S conforming to IS: 269 (as amended upto date). However, upper limit of SO₃ and C₃A content in 53-S grade cement is revised as 3.3% & 9.0% respectively for improvement in quality of PSC sleepers on IR. Upper limit of initial setting time (IST) of 53-S grade cement is specified as 120 minutes preferably but not more than 150 minutes.
- 3.2.2 Each consignment of cement shall be covered by a test certificate. Each consignment shall be stocked separately, tested in the laboratory of the plant immediately for all relevant properties and shall be clearly identified. Cement more than 3 months old, if free from lumps, shall be tested for physical properties by an independent government approved laboratory or as directed by the Inspecting Officer and may be used after his approval.
- 3.2.2.1 The Inspecting Officer has the right to have the cement in stock tested at any time at the cost of manufacturer.
- 3.2.2.2 In case the source of supply of cement is changed, the mix design shall be reviewed and modified, if necessary, as per instructions given in para 3.6.3.1.
- 3.2.3 The cement content of the mix shall not be less than 350 kg/cu. m. and not more than 450 kg/cu.m.

3.3 **Admixture**

- 3.3.1 Super Plasticizer conforming to IS: 9103 may be used with the prior approval of RDSO. At this stage the revised concrete mix design shall also be submitted to RDSO for approval. However, following shall be observed:
- 3.3.2 Use of any admixture containing chloride in any form is prohibited.
- 3.3.3 Generally one admixture at a time should be used.
- 3.3.4 The admixture should be stored as per specified conditions by its manufacturer and its shelf life should be monitored continuously. Regular testing of admixture shall be done annually from NABL approved laboratory/NCCBM/IITs/NITs.
- 3.3.5 All containers should be correctly labeled. Reliable liquid dispenser for liquid admixtures should be used and calibrated.
- 3.3.6 The admixture containing Cl and SO₃ ions shall not be used. Admixtures containing nitrates shall also not be used. Admixture based on thiocynate shall be prohibited.

3.4 **Aggregates**

- 3.4.1 The aggregates shall conform to IS: 383 and shall, before use, be got tested through an approved testing institute, and results submitted in accordance with Annexure B of IS: 383 to the Inspecting Officer for approval. These tests shall be got done at the manufacturer's cost once in a year or at the time of approval/review of mix design or as desired by inspecting official. The aggregates shall have maximum 30% abrasion and maximum 30% impact value suitable for wearing surfaces when tested in accordance with IS:2386 (Part-IV). Flakiness & elongation shall be determined in accordance with IS 2386 (Part-I) on the same sample. The combined flakiness and elongation index so obtained shall not exceed 40 % when tested in accordance with IS: 2386 (Part-I).
- 3.4.2 Coarse and fine aggregates shall pass sodium or magnesium sulphate accelerated soundness test specified in IS: 2386 (part V).
- 3.4.3 Aggregates shall not contain harmful material such as pyrites, coal, lignite, mica shale or similar laminated material clay, alkali, free lime, soft fragments, sea shells and organic impurities in such quantity as to affect the strength or durability of concrete. Aggregate to be used for reinforced concrete shall not contain any material liable to attack steel reinforcement. Maximum limit of deleterious material in aggregates should conform IS: 383 when tested in accordance with IS: 2386 (Part-II).
- 3.4.4 Aggregates which are reactive with alkalies of cement are harmful as cracking of concrete may take place. Potential reactivity of aggregates shall be tested as per IS:2386 (part VII).
- 3.4.5 Coarse aggregates shall be crushed stone, angular in shape and gravel shall not be used.
- 3.4.6 Different sizes of aggregates shall be stacked in different storage bins or stock piles on proper hard floor surface. The bins near batching plant must be located under a covered shed to avoid any chance of raw material getting wet due to rains. Alternatively, auto sensors may be used to record the moisture content in the aggregate along with auto mechanism for adjusting water to be added to concrete in the weigh batcher.
- 3.4.7 If crushed stone sand is being used as fine aggregates then bond strength (pull out test) of concrete shall be tested as per IS: 2770 (Part I) during mix design approval and after production of every 5000 sleepers during regular production.

3.6.3 Concrete mix shall be designed as per guidelines in IS: 10262 and complying design parameters as per para 3.6.2 by the sleeper plant, checked by zonal railways and got approved from RDSO before start of the sleeper production. RDSO will check and verify the new mix design at the sleeper plant by testing of trial cubes as per para 3.6.4 and complying design parameters as per para 3.6.2.

3.6.3.1 Zonal railways shall review the concrete mix design themselves whenever the source of cement or water or admixture is changed as per guidelines in IS: 10262 provided the quantity of cement is not reduced. All new ingredients must be got tested before hand from reputed laboratory to ascertain whether they are suitable to be used as per relevant standards/specifications. The copy of test report of all ingredients, mix design calculations, record of trial cube testing and records of modification should be communicated to RDSO for information and should be available with zonal railway as well as with CSP, so that the same can be inspected during oversight inspection by RDSO official. However, if the source of aggregate changes, RDSO should be approached by the zonal railways for approval of the source and also for reviewing/revising the mix design.

Zonal Railway or RDSO will check and verify the revised mix design at the sleeper plant by testing of trial cubes as per para 3.6.4 and complying design parameters as per para 3.6.2.

3.6.3.2 Workability of mix should be kept low i.e. compacting factor in range of 0.75-0.80 for stress bench method. For long line method, workability should be kept slightly higher with slump up to 25mm if required, for proper compaction of concrete, but not leading to segregation to constituents of concrete mix under vibrations.

3.6.4 At the time of approval/review of mix design, 80 cubes shall be cast, using materials proposed for regular manufacture, in 10 separate concrete batches of 8 cubes each, 4 for steam curing and 4 for water curing.

3.6.4.1 All the 40 cubes cured according to the proposed steam curing cycle shall attain the specified minimum release strength.

3.6.4.2 The statistical analysis of the compressive strength values of the 40 water cured cubes shall satisfy the design parameters of clause 3. 6.2 (ii), (iii) & (iv).

3.7 SGCI Inserts

3.7.1 SGCI inserts shall conform to IRS Specification No.T-46 as amended up-to-date and will be procured only from RDSO

approved manufacturers. Each consignment of SGCI inserts shall be accompanied by a test certificate from inspecting agency for inspection conducted prior to dispatch of consignment from supplier's premises.

- 3.7.2 Whenever directed by the inspecting official, the sleeper manufacturer shall get the SGCI inserts in stock tested at his own cost.

4. MANUFACTURE

4.1 Moulds

Moulds shall be of steel with minimum plate thickness of 10 mm in Rail seat area as well as for end plates. For other locations minimum plate thickness is to be 6 to 8 mm. Moulds shall be of rigid construction so as to prevent any in-service distortions. Moulds shall not allow any appreciable leakage of cement mortar in casting. The holes in the end plates shall be accurately drilled for correct placement of prestressing wires.

4.2 Stretching of wires

The prestressing wire shall be stretched either individually or collectively by an approved method. The tensioning force shall be as shown on the sleeper drawing. The final force to be adopted, duly considering the losses while stretching shall be approved by the Inspecting Officer. However, the stretching force shall in no case exceed 75% of the minimum specified UTS of the wire. The pre-tensioning force in the wire shall be applied by a tensioning device equipped with automatic load cut off unit along with measuring gauge. The final force shall also be verified by measuring the extension of the wire.

4.3 Mixing and consolidation of concrete

- 4.3.1 Manufacture of sleepers shall be done under a shed.
- 4.3.2 Batching of different ingredients shall be done by weight only. A modern, mechanized, or automatic weigh batcher shall be used for weighing aggregates and cement. The weigh batcher shall have an accuracy of +/- 3% for aggregate, admixtures & water and +/- 2% for cement.
- 4.3.3 Modern high speed mixer, pan, turbine or any other suitable type, approved by the Inspecting Officer shall be used for mixing concrete. Concreting shall commence within 2 hours of stressing of wires, failing which the HTS wires shall be checked and re-tensioned, if necessary.
- 4.3.4 Concrete shall be thoroughly mixed and consolidated by means of vibrators of at least 9000₊₄% revolutions/minute. The vibrator should normally be fixed at the bottom of the mould, at

least at two different locations for a sleeper. Any other vibration system should have prior approval of RDSO.

- 4.3.5 Freshly cast sleepers shall be protected during the first stage of hardening from adverse weather conditions.

4.4 De-tensioning of wires

Anchoring system shall provide a device for gradual de-tensioning of the wires. Back pulling of wires for releasing any wedge shall be strictly prohibited. De-tensioning of wires shall be undertaken only after the concrete has attained a compressive strength of 40 N/sq.mm.

4.5 Curing

- 4.5.1 Initial curing of concrete sleeper shall be done by steam at atmospheric pressure till the concrete attains a compressive strength of 40 N/sq.mm. Pre-steaming period shall not be less than the initial setting time of cement.

Total steam curing cycle duration can vary approximately from 10 to 12 hours depending on time taken in the steam curing stages e.g. presteaming, temperature rising (heating), constant temperature duration, cooling etc. Total cycle time depends on ambient temperature.

- i) Normal pre-steaming period is recommended as 2 hours or initial setting time (IST) of cement whichever is greater.
- ii) Temperature rising time is recommended as 2.0 to 2.5 hours keeping maximum rate of rise of temperature as 15°C per hour.
- iii) Maximum steam curing temperature shall be not more than 60°C keeping constant temperature in range of 55 – 60°C. Constant temperature duration can be kept between 3.5 to 5.0 hours.
- iv) Cooling of sleepers shall be gradual and cooling period is recommended in range of 2 to 3 hours with cooling rate not exceeding 15°C per hour.

Extra one hour cooling of sleepers after taking out from steam curing chamber at ambient temperature before demoulding is desirable/recommended to minimize difference in external and internal (inside) temperature of sleepers.

Mix design shall be revised, if minimum strength of 40 steam cured cubes is less than 40 N/mm² following the above mentioned stipulations on steam curing cycle. The steam

curing cycle which is proposed to be adopted shall have prior approval of the inspecting official.

4.5.2 After de-tensioning & de-moulding, the sleepers shall be cured for a further period of not less than 14 days (as per mix design) by submerging in water. Water used for curing should conform to the quality prescribed for water to be used for concrete mix.

4.5.3 Each steam chamber in stress bench method or production line in long line method shall be attached with a separate digital thermal sensor, temperature shall be recorded continuously and record shall be maintained.

4.6 Supervision

4.6.1 Suitably qualified persons as per Schedule of Technical Requirement shall be engaged by the manufacturer for supervising the following items at the works:

- i) Placing and stressing of prestressing wire;
- ii) Batching, mixing, placement and compaction of concrete. Checking of the steam curing arrangement for its adequacy.
- iii) De-moulding of sleepers, water curing, stacking/ loading etc.
- iv) Inserts shall be checked by suitable jigs before use by the manufacturer.
- v) Testing of cement, cement mortar cubes, concrete cubes, concrete beams;
- vi) Calibration of testing and measuring equipment and different gauges;
- vii) Checking electrical resistance of sleepers.

4.6.2 Supervisor so engaged shall maintain records as directed by the Inspecting Officer and shall present them for scrutiny when demanded.

- i) A site register shall be maintained in which inspecting officer shall record observations against which compliance will be recorded by the supervisor.
- ii) Suitable records as per Schedule of Technical Requirement shall be maintained in such a manner that it can be correlated at a later date to the sleeper laid in field.

4.7 **Finish**

4.7.1 All sleepers shall be free from surface defects such as water retaining pockets, air holes or honey combed formations. The underside of the sleeper coming in contact with ballast shall be left rough but the unevenness shall not exceed 5mm. The ends of the prestressing wires shall be cut close to the surface of the sleeper in such a way that there is minimum damage to end plate and the wire in no case shall project more than 3 mm from the concrete surface. Two coats of suitable ISI mark anti corrosive paint, approved by Inspecting Officer, shall be applied at the ends of the sleepers in the following manner:

- i) First coat of paint, sufficient thick to form impervious film of paint covering full surface of either ends of a sleeper shall be applied just after de-moulding from sleepers mould, and
- ii) Second coat after taking out the sleepers from submerged water curing tank in the above manner, ensuring that surface to be painted is completely dry and clean of dirt etc.

4.7.2 No touching up or finishing by cement mortar etc. shall be permitted on concrete sleeper, after it is de-moulded, except as provided in clause 4.7.3.

4.7.3 Such sleepers which are not found acceptable due to surface defects, shall be accepted up to a ceiling of 1% of the supplies made any time during the currency of the contract provided such sleepers are adequately treated with epoxy compounds to the satisfaction of the Inspecting Officer. However, epoxy treatment of rail seat area is not acceptable. These sleepers shall be marked as shown in Drawing No.RDSO/T-2466 before dispatch. The rectified sleepers shall be paid for at the rates fixed by the Purchaser.

4.8 **Stacking**

After the sleepers have been cured in terms of clause 4.5.2 and checked both dimensionally and visually they shall be stacked at convenient place in lots. The stacking of sleepers shall be done on leveled and consolidated ground, one over another up to 25 layers. Each layer shall be separated by wooden/concrete battens of 50mm x 50mm size for sleepers having Insert to drawing no.RT-381 and 60mm x 60mm for sleepers having Insert to drawing no.RT-6901, of suitable lengths to avoid any damage.

4.9 **Lots**

All sleepers cast in one shift shall form one lot.

5. INSPECTION AND TESTING

- 5.1 The manufacturer shall supply at his expense, all the sleepers required for tests and retests, samples of materials, labour, machine, tools, gauges, apparatus, forms of test reports etc. and any other item which may be necessary or required by the Inspecting Officer for carrying out any or all of the checks and tests mentioned in these specifications and shall render all reasonable assistance in conducting such checks and tests. All measuring and testing appliances shall be got checked and calibrated according to the schedule given in Annexure-I, through government approved agency or as directed by the Inspecting Officer. The calibration certificate shall be furnished to the Inspecting Officer. The cost of all such checks and calibrations shall be borne by the manufacturer.

The plant controlling Railway officer minimum JAG level have liberty to recalibrate the various gauges and testing equipments in the concrete sleeper plant or by engaging the external government approved agency who can bring their calibration equipments at the plant itself, whenever they consider necessary. The necessary arrangements will be facilitated by the manufactures and cost will be borne by the manufacturer.

- 5.2 Inspecting Officer and the Purchaser shall have free access at all reasonable times to the works in which the sleepers are manufactured. They shall be at liberty to inspect the manufacture of sleepers at any stage and to reject any material supplies not conforming to the terms of the specifications and to reject sleepers not manufactured according to approved manufacturing process. They shall be provided with necessary assistance for inspection by the manufacturer.

5.3 Checks and tests

- 5.3.1 In addition to the control checks exercised on the materials and manufacturing process specified above, the concrete and the finished sleepers shall be subjected to regular checks and tests, after 14 days submerged water curing, as detailed in clause 5.3.1.1.

5.3.1.1 Visual and Dimensional Check

Every sleeper shall be visually inspected for surface finish. No sleeper shall have surface defects except as provided in para 4.7.3.

Sleeper dimensions to be checked are listed below:

- (i) Critical dimensions are toe gap, location of inserts, distance between inserts at rail seat, distance between outer most inserts and slope at rail seat.

- (ii) General dimensions are depth of sleeper at centre, rail seat and end of sleeper; width of sleeper at top and bottom; length of sleeper, camber and wind at rail seat and position of high tensile steel wires at ends.

The sketch at Annexure-II shows the dimension checking arrangement. The dimensions, shown on the sleeper drawing, shall be checked by means of approved gauges, procured by the manufacturer. (Annexure II/A & II/B shows the gauges for measuring toe gap of rail seat).

- (iii) Scale of check
 - a) Prior to stabilization of production technique*:- Scale of check per lot for critical dimension is 100% (hundred percent) and for general dimensions 10% (ten percent) of sleepers produced.
 - b) After stabilization of production technique* :- Scale of check per lot for critical dimensions is 10% (ten per cent) and for general dimension 1% (one percent), but the dimensions between outer inserts shall be checked 100%.
 - c) Notwithstanding the provisions in (a) & (b) above the Inspecting Officer may decide to check the dimensions at scale higher than mentioned in para (a) & (b) above.

* Acceptance of minimum 10000 sleepers and achieving rejection rate less than 2% consistently, whichever is later, shall be one of the major criteria for deciding the stabilization of the manufacturing technique. After stabilization, the rejection rate shall be assessed after every 30000 numbers sleeper production and if it is found beyond 2%, then all the testing have to be done as per the frequency prescribed for pre-stabilized production. The additional cost of sleepers required for testing shall be borne by the firm.

5.3.2 Casting of cubes

15 cm size cubes shall be cast on a vibrating table conforming to IS: 2514 from random samples spread over the entire lot, out of concrete used for casting sleepers for testing prior to transfer of prestress and 15 days.

5.3.2 Method of testing

The cubes shall be surface dry at the time of testing. The rate of loading shall be about 400 KN/minute.

5.3.4 Compressive strength of concrete at transfer (release) of prestress

These cubes shall be steam cured along with sleepers in the same manner and tested for transfer of prestress to concrete (at least one cube for every steam chamber/3 for each long line but not less than a total of 3 in any case).

5.3.5 Test for 15 day compressive strength of concrete

These cubes shall not be steamed but shall be water cured for 14 days after de-moulding. Two number of samples per lot (one sample comprises of 3 cubes) shall be taken.

The samples should be spread over the entire period of concreting in a lot. Cubes of these samples shall be tested for 15 days compressive strength of concrete. The test result of a sample shall be the average of the strength of three cubes. Individual variation in cube strength in a sample should not be more than $\pm 15\%$ of the average. If variation is more than $\pm 15\%$, the test results of the sample is invalid and the lot shall be rejected.

Further, if mean of two test results of two samples is $< f_{ck}$ and / or minimum of the two test results of two samples is $< f_{ck} - 5$ N/mm², the lot shall also be rejected. Where, f_{ck} is characteristic strength of concrete i.e. 55 N/mm² for M55 and 60 N/mm² for M60 grade of concrete.

Otherwise, the concrete is accepted for further testing of sleeper/s as per para 5.3.7.2.2.

5.3.6 Test for 15 day modulus of rupture of concrete

The test for 15 day modulus of rupture of concrete shall be carried out on concrete beams of 10 x 10 x 50 cm size as specified in IS: 516. One specimen shall be tested daily prior to the stabilization of production technique, and once a week thereafter. If any value falls below 5.2 N/mm² for M55 and 5.5 N/mm² for M60, the mix design shall be reviewed.

5.3.7 Tests for static bending strength of sleepers

5.3.7.1 Method of testing

5.3.7.1.1 The tests shall be conducted in accordance with the arrangement shown in Annexure-III.

5.3.7.1.2 The sleepers shall be loaded gradually (30-40 KN/min) upto the specified load, which will be retained at this level for three

minutes for observing cracks, if any. For the purpose, a crack is defined as one which is barely visible to the naked eye and is at least 15mm long from the tension edge of the sleeper. However, if crack appears at a load smaller than the specified load, that value shall be recorded.

5.3.7.1.3 In case of 'Moment of Resistance' (MR) test, the sleeper shall be deemed to have passed the test if it sustains the loads specified in relevant sleeper drawing without cracking. While loading, load can be applied upto 5KN in excess of specified load.

5.3.7.1.4 In case of 'Moment of failure' (MF) test, the sleeper shall be deemed to have passed the test if it is able to take load beyond the specified test load. The initial cracking loads shall also be recorded for rail seat bottom, centre top and / or centre bottom (as the case be) for further statistical analysis of data during MF test.

5.3.7.1.5 Sleepers for test shall be selected randomly by the inspecting officer.

5.3.7.2 Acceptance tests

5.3.7.2.1 Moment of failure (MF) test (for rail seat bottom)

Prior to stabilization of production technique, one sleeper for every 250 sleepers manufactured shall be tested. After the production technique gets stabilized the testing scale shall be reduced to one sleeper for every 2500 sleepers produced.

5.3.7.2.2 Moment of resistance (MR) test (Rail seat bottom, centre top, centre bottom)

Depending on 15th day test results of samples of the lot as mentioned in para 5.3.5, the scale of testing of sleepers for the lot shall be as follows (as explained in Table -1):

- i) Wherever mean of the two test results of two samples is $\geq f_{ck} + 3 \text{ N/mm}^2$ or $f_{ck} + 0.825 \times$ established standard deviation whichever is greater and minimum of the two test results of two samples is $\geq f_{ck} - 3 \text{ N/mm}^2$ and the lot is not rejected as per the criteria given in para 5.3.5– one sleeper per lot
- ii) Wherever mean of two test results of two samples is $< f_{ck} + 3 \text{ N/mm}^2$ or $f_{ck} + 0.825 \times$ established standard deviation whichever is greater but $\geq f_{ck}$ or minimum of the of the two test results is $< f_{ck} - 3 \text{ N/mm}^2$ but $\geq f_{ck} -$

5 N/mm² or both and the lot is not rejected as per the criteria given in para 5.3.5 – two sleeper per lot

- iii) In case, mean of two test results of two samples is < f_{ck} and /or minimum of the two test results of two samples is < $f_{ck} - 5$ N/mm², the lot shall be rejected and no testing for moment of resistance or moment of failure will be conducted.

Note:

- a. Prior to stabilization of production technique: Sleeper to be tested shall be subjected to rail seat bottom, centre top and centre bottom tests.
- b. After stabilization of production technique: Sleeper to be tested shall be subjected to rail seat bottom and centre top tests only.

Table -1: Acceptance / Rejection Criteria of Concrete and No. of Sleepers for SBT Test per Lot

SN	First condition	Second Condition	Conditions to be complied	No. of sleeper per lot for test
Case 1	If average of test results of two samples is $\geq f_{ck} + 3$ N/mm ² or $\geq f_{ck} + 0.825$ x established standard deviation, N/mm ² whichever is greater	If minimum of test results of two samples is $\geq f_{ck} - 3$ N/mm ²	Both conditions are to be fulfilled and the lot is not rejected as per the criteria given in para 5.3.5.	Concrete is accepted and one sleeper will be tested for SBT from the lot.
Case 2	If average of test results of two samples is $< f_{ck} + 3$ N/mm ² or $< f_{ck} + 0.825$ x established standard deviation, N/mm ² whichever is greater but $\geq f_{ck}$ N/mm ²	If minimum of test results of two samples is $< f_{ck} - 3$ N/mm ² but $\geq f_{ck} - 5$ N/mm ²	Any one of them or both conditions are fulfilled and the lot is not rejected as per the criteria given in para 5.3.5	Concrete is accepted but two sleepers will be tested for SBT from the lot.
Case 3	If average of test results of the two samples is $< f_{ck}$ N/mm ²	If minimum of test results of two samples is $< f_{ck} - 5$ N/mm ²	Any one of them or both condition are fulfilled.	Lot rejected without any further testing on sleepers of the lot.

5.3.7.3 Acceptance of 'lots'

5.3.7.3.1 All sleepers tested in accordance with clause 5.3.7.1 should pass all the acceptance tests provided in clause 5.3.7.2 for the lot to be accepted. The specified values of Load for Centre Top, Centre bottom, Rails Seat cracking and MF test shall be as per relevant RDSO's drawings of various PSC sleepers.

5.3.7.3.2 If the sleeper fail in any of the tests conducted as per clause 5.3.7.2.2 (i), the lot shall be subjected to 'retest' as per clause 5.3.7.4.

5.3.7.4 RETEST

5.3.7.4.1 Moment of resistance (MR) test

For every sleeper failed in acceptance tests as per clause 5.3.7.2.2 (i), two more sleepers from the same lot shall be retested as per clause 5.3.7.2.2.

However, in case of testing of two sleepers as per clause 5.3.7.2.2(ii), if any of the sleepers fail, the lot shall be rejected.

5.3.7.4.2 Moment of failure (MF) test

In case of failure of the sleeper in MF test as per clause 5.3.7.2.1, 2 more sleepers from the same lot shall be selected for testing in MF as per clause 5.3.7.2.1 and 5.3.7.2.2 and subjected to all relevant tests. However, if the sleeper has passed MF test and failed in some other test MF test need not be repeated on subsequent sleepers subjected to testing.

5.3.7.4.3 For acceptance of the lot, all the sleepers tested in 'retest' must pass all the tests conducted. However, sleepers failing in any static bending tests shall not be paid for.

Also final passing of the lot is a prerequisite condition for payment for any sleeper having passed all the relevant tests conducted on that sleepers.

Sleeper/sleepers tested for rail seat bottom failure test and passes the test, shall be paid by the purchaser, if that particular lot passes all the relevant retests.

NOTE:

In case where more than one test value is obtained in retests. The lowest value obtained will be taken as strength of the lot for deciding the result of the lot.

5.3.7.5 Testing of PSC sleeper in Zonal Railways testing facility or at RDSO

Three/Four sleepers due for testing selected randomly at the level of minimum JAG will be sent for Static Bend Test (SBT) and Moment of Failure (MF) test to RDSO or at testing facilities available with Zonal Railways such as 'Bridge Workshops/'Soil Testing Lab' or any other Lab of Open line / Construction Unit of Zonal Railways for a frequency not less than once in a year. Zonal Railways should choose testing agency either RDSO or Railways who can perform the testing within 7 to 14 days including transportation time. Out of which one sleeper selected randomly will be tested. If sleeper fails in any of the test as per clause 5.3.7.1, the other two sleepers shall be subjected to retest as per clause 5.3.7.4. The testing cost including transportation etc. for above testing will be borne by the Railway.

If the sleeper fails in above testing:

- (i) All sleepers manufactured in that batch will be rejected and re-calibration of the all gauges and various testing equipments in the sleeper plant is to be carried out at manufacturers cost.
- (ii) Three/four sleepers from next one batch will also be got tested for Static Bend Test (SBT) and Moment of Failure (MF) test as above from RDSO or at testing facilities available with Zonal Railways such as 'Bridge Workshops/'Soil Testing Lab' or any other Lab of Open line / Construction Unit of Zonal Railways. In case of failure of sleeper in any of the test as per clause 5.3.7.1, two sleepers from the same batch shall be subjected to retest as per clause 5.3.7.4. In case failure of sleepers from next one batch, the concerned batch shall be rejected and further production shall be suspended. The detailed enquiry of the concerned sleeper plant is to be ordered by PCE of Zonal Railway. In addition, the quality audit is to be ordered by an Officer not below the rank of JAG.

All precautions should be taken during handling & transportation of sleepers for outside testing so that these are not received in cracked Condition for testing. The condition of the sleepers received before testing shall also be mentioned in the test report.

- (iii) The sleeper plant representative can be permitted to witness the transportation of sleepers and the testing in RDSO/Railways Lab.

5.3.8 Measurement of electrical resistance

- 5.3.8.1 All sleepers shall be tested as per Annexure-V for electrical resistance for their fitness for use in track circuited area.

5.3.8.2 **Competency Certificate**

For inspection of concrete sleepers, officials having competency certificate issued after due test by RDSO/Chief Track Engineer only shall be posted.

6. STAMPING AND MARKING

6.1 All the sleepers shall have legible permanently inscribed and painted markings on the top as per drawing No.RDSO/T-2466.

6.2 The accepted sleepers shall bear the passing marks of the Inspecting Officer in indelible paints. Sleepers which have been subjected to static bending strength test up to cracking and accepted, shall in addition be marked on the top in indelible paint with the letter 'T'. MF tested and accepted sleepers shall bear the marking 'MF' in paint with yellow bands at ends.

6.3 All sleepers fit for use in track circuited area shall bear the mark 'FTC' at the center of the sleeper.

6.4 Rejected sleepers shall be stacked separately by the manufacturer so as to avoid their mixing with the accepted sleepers. Such rejected sleepers shall be marked in the way specified in drawing No.RDSO/T-2466.

The rejected sleepers shall be permanently damaged so as to render them un-useable and a certification that all rejected sleepers of previous batches have been permanently damaged will be given by manufacturer before offering next batch for inspection. The same shall be verified and ensured by inspecting officials/ SSE's and AIE before issuing the IC.

6.5 All markings mentioned in para 6.1 to 6.3 shall be done with enamel paint of ISI mark and shall be such as to last for at least 3 years under normal weather conditions. Colour and quality of the paint used shall be got approved by the Inspecting Officer. All such markings shall be done by the manufacturer at his cost.

7. LOADING AND DESPATCH

7.1 Only those sleepers which have been passed, properly marked and accepted by the Inspecting Officer shall be loaded for despatch.

7.2 The loading of the passed sleepers in wagon shall be done by the manufacturer at his cost as per the loading arrangement

approved by the purchaser. The sleepers shall be properly secured to avoid movement and displacement during transit. The manufacturer shall be responsible to replace, free of cost, all the sleepers which are found damaged in transit on account of defective loading.

8. GUARANTEE

- 8.1 The sleepers shall be guaranteed by the manufacturer for a period of five years from the date of manufacturing / 3 years from the date of placement in service (whichever is earlier). If during the guarantee period, sleepers in general are found to develop defects attributable to bad material and workmanship as established during investigation, leading to large scale withdrawal from service, the cost of sleepers and their replacement shall be borne by the manufacturer. The defective sleepers withdrawn from service can be taken over at site by the manufacturer for their disposal. The manufacturer shall make good the cost due within 60 days of advice of defects. The sleeper manufacturer will also be involved during inspection / investigation and his view will be considered by the Purchaser before taking decision. The decision of the purchaser shall be final and binding in this regard.

ANNEXURE-I**SCHEDULE FOR CALIBRATION OF VARIOUS GAUGES AND TESTING EQUIPMENTS IN THE CONCRETE SLEEPER PLANT**

S.No.	Equipment	Frequency
1	15 cm concrete cube testing machine (2000 KN capacity)	Once in 3 months
2	Cement mortar cube testing machine (500 KN capacity)	Once in 6 months
3	Sleeper Static Bend Test Machine (1000 KN capacity)	Once in 3 months or after testing 250 sleepers, whichever is earlier.
4	Pre tensioning Jacks (500 KN capacity for single mould bench) & (1000 KN Capacity for twin mould bench)	Once a month or after casting 5000 sleepers for single mould and once a month or after casting 10,000 sleepers for twin mould, whichever is earlier.
5	Pre-tensioning load cell	Once a month or after casting 5000 sleepers for single mould and once a month or after casting 10,000 sleepers for twin mould, whichever is earlier.
6	Concrete Beam Testing Machine (100 KN capacity)	Once in 6 months
7	Aggregate weight batcher	Once every week or after casting 4000 sleepers, whichever is earlier.
8	Cement weighing equipment	Once every week or after casting 4000 sleepers, whichever is earlier.
9	Water Meter	Once every week or after casting 4000 sleepers, whichever is earlier.
10	Admixture dispenser	Once every week or after casting 4000 sleepers, whichever is earlier.
11	Master gauges for checking correctness of dimension measuring gauges	Once in 6 months
12	Dimension checking gauges	Once every 15 days or after inspecting 5000 sleepers, whichever is earlier.
13	Proving rings (2000 KN, 500 KN, 1000 KN and 100 KN capacity)	Once in 24 months or within the validity period of last calibration, whichever is earlier.
14	Weights & Measures	By Weights & Measures Department as per extant rules.
15	Tachometer	Once a year

Note:

1. The items referred at S.No.1 to 6 above should be calibrated by proving rings in the sleeper plant itself.
2. The items referred at S.No.7, 8, 9 & 10 should be calibrated by dead weights.
3. The proving rings should be got calibrated from NABL approved laboratory / NCCBM/IITs/NITs.

4. The record of calibration of all the above equipments should be maintained in a manner that previous records can be easily connected.
5. The calibration can be done more frequently at the discretion of the Inspecting Official.

DIMENSIONS CHECKING ON PSC SLEEPER

CONVEX OR CONCAVE CAMBER
IN ANY DIRECTION ON RAIL
SEAT SHALL NOT EXCEED 0.8mm.

RAIL SEAT SLOPE 1 IN 20±0.25

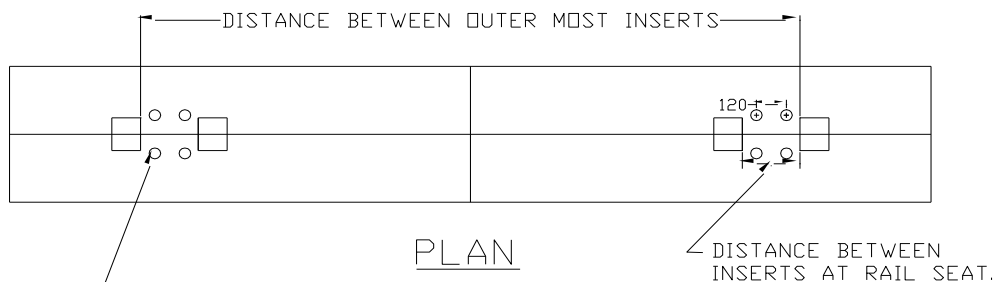
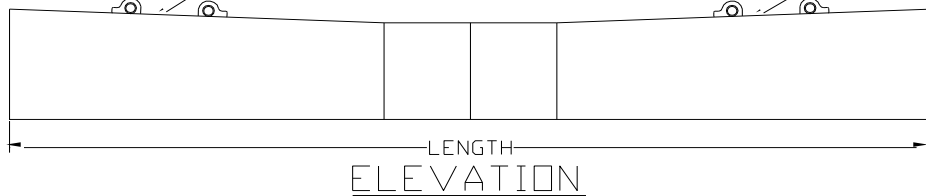

GAUGING POINTS FOR MEASURING
INCLINATION AND WIND AT RAIL
SEATS. WIND SHALL NOT EXCEED
1.2mm ON WIDTH OF 120mm.

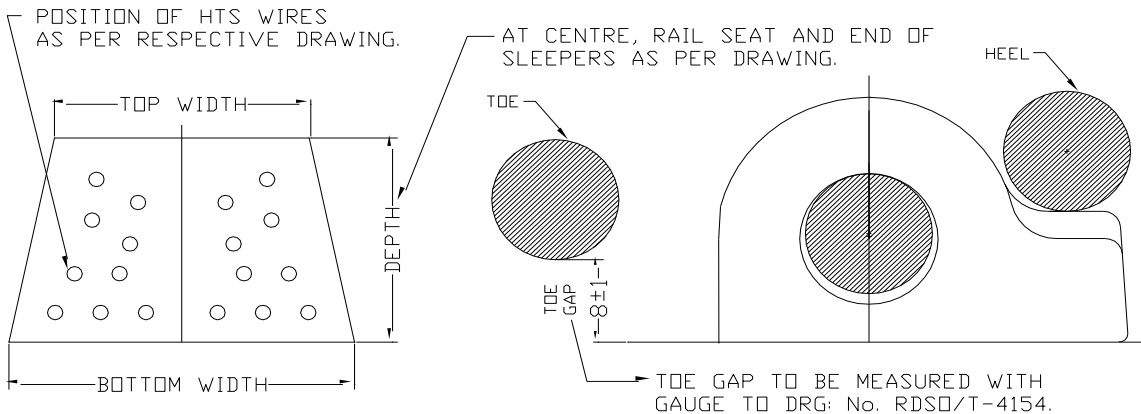

NOT TO SCALE

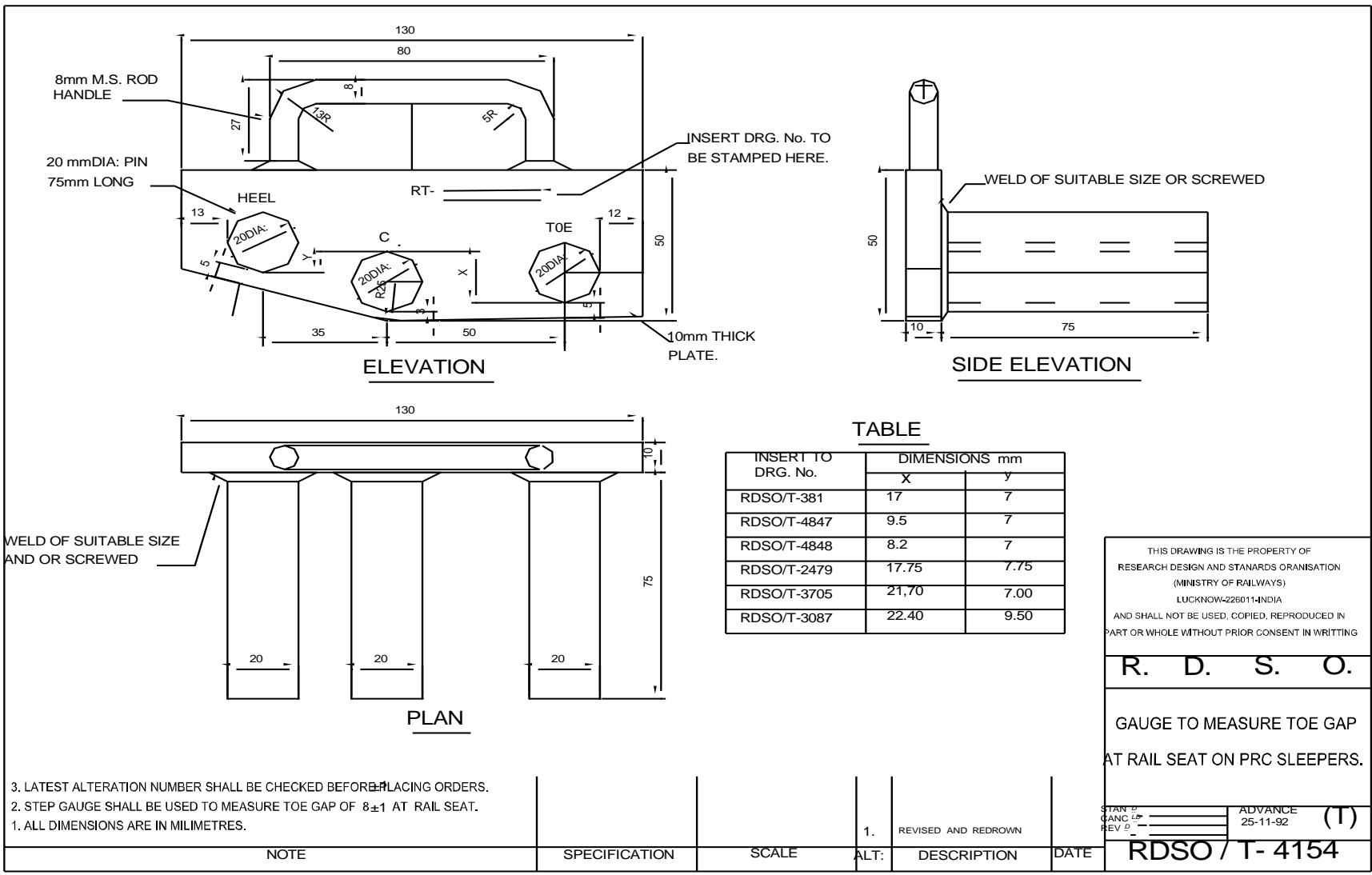

TABLE

INSERT TO DRG. No.	DIMENSIONS mm	
	X	y
RDSO/T-381	17	7
RDSO/T-4847	9.5	7
RDSO/T-4848	8.2	7
RDSO/T-2479	17.75	7.75
RDSO/T-3705	21.70	7.00
RDSO/T-3087	22.40	9.50

THIS DRAWING IS THE PROPERTY OF RESEARCH DESIGN AND STANDARDS ORGANISATION (MINISTRY OF RAILWAYS) LUCKNOW-226011-INDIA AND SHALL NOT BE USED, COPIED, REPRODUCED IN PART OR WHOLE WITHOUT PRIOR CONSENT IN WRITING

R. D. S. O.

GAUGE TO MEASURE TOE GAP AT RAIL SEAT ON PRC SLEEPERS.

- 3. LATEST ALTERATION NUMBER SHALL BE CHECKED BEFORE PLACING ORDERS.
- 2. STEP GAUGE SHALL BE USED TO MEASURE TOE GAP OF 8 ± 1 AT RAIL SEAT.
- 1. ALL DIMENSIONS ARE IN MILLIMETRES.

STAMPED ADVANCE (T)
GANC 25-11-92
REV D

NOTE	SPECIFICATION	SCALE	ALT: 1.	REVISOR: REVISED AND REDROWN	DATE	RDSO / T- 4154
------	---------------	-------	---------	------------------------------	------	----------------

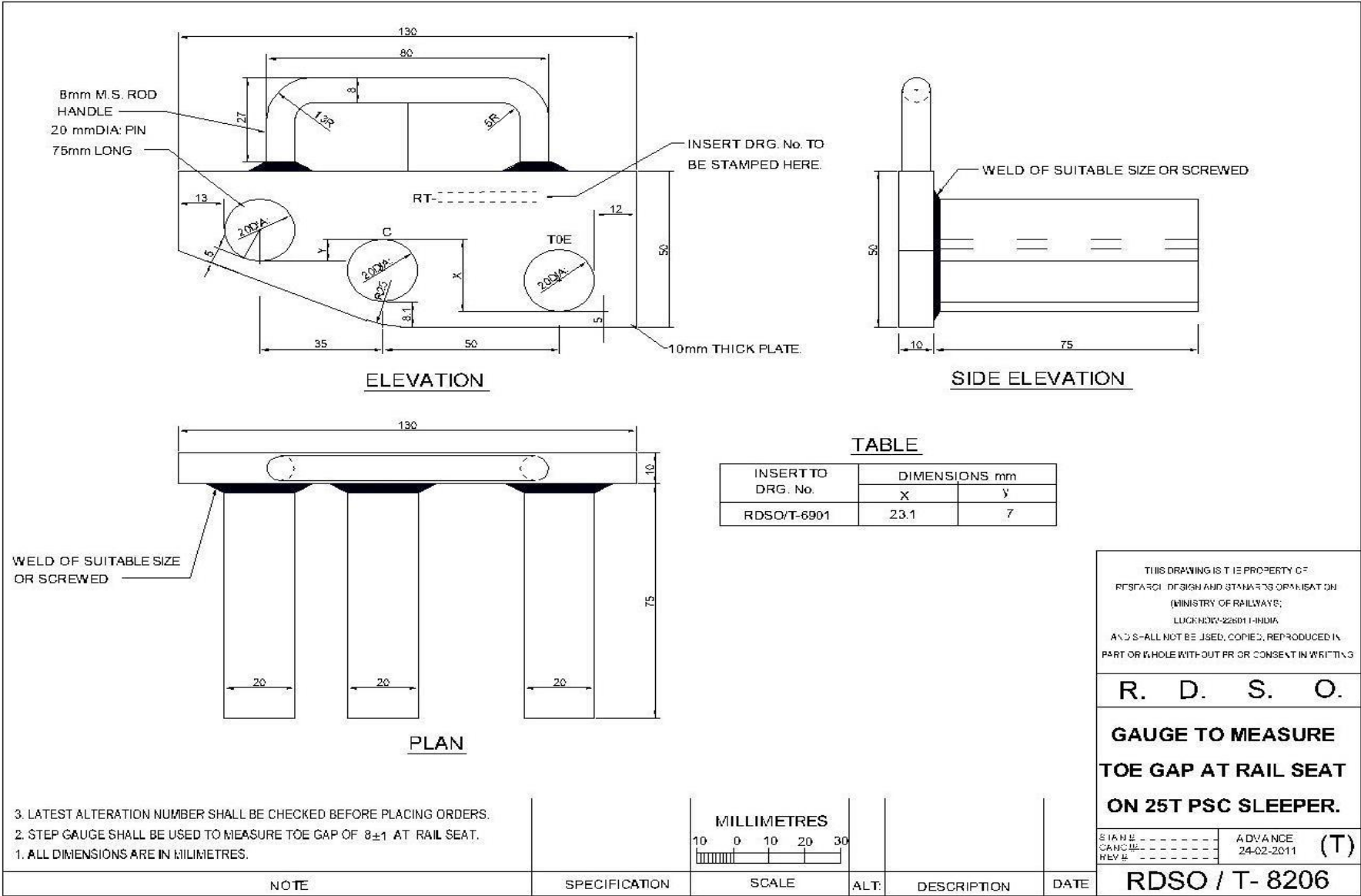

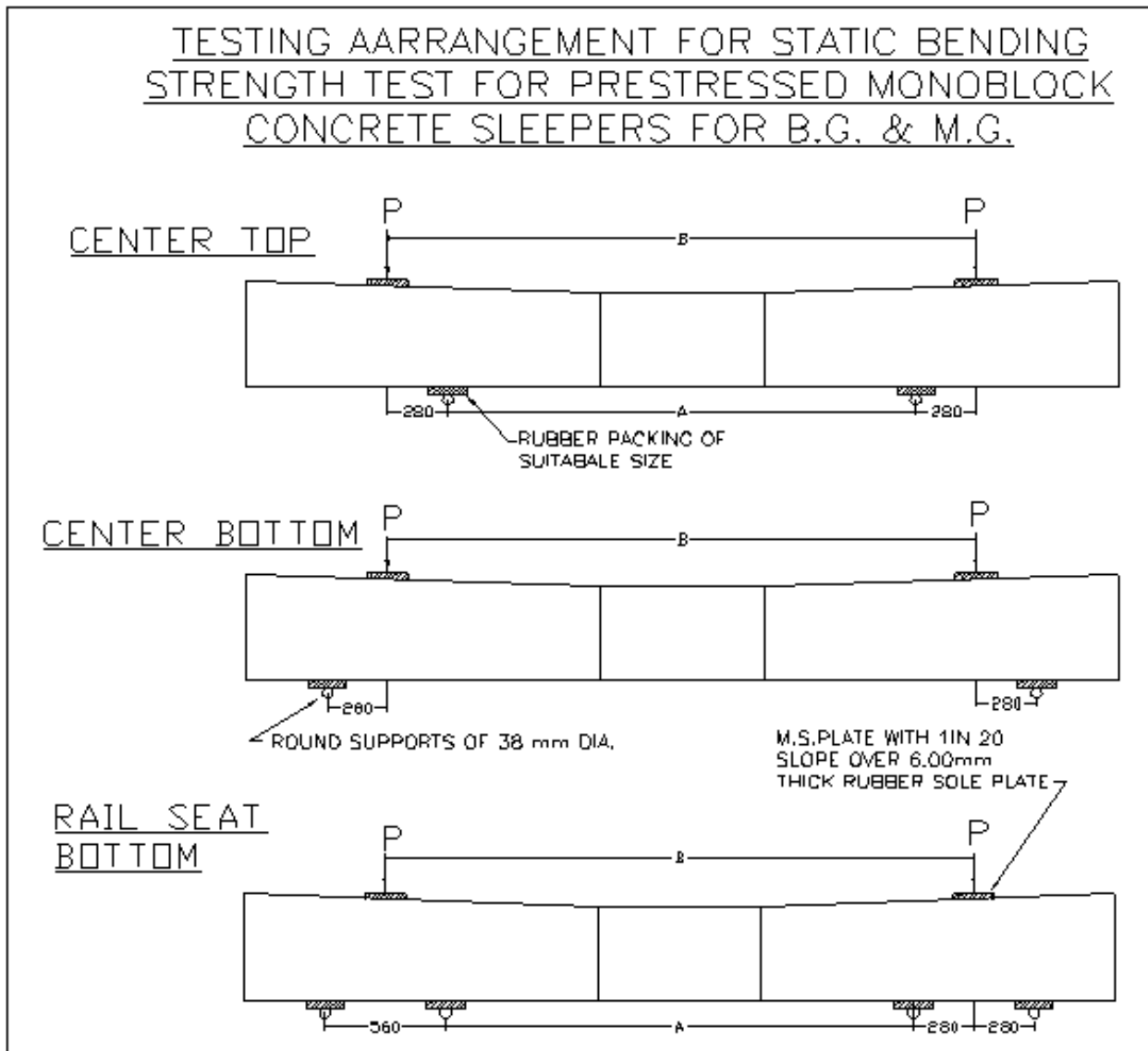

Note:- The testing arrangement is for guidance purpose only. Testing shall be conducted as per test loads mentioned in the relevant RDSO's drawings of PSC sleepers. The dimensions A & B mentioned in above testing arrangement shall be referred from relevant RDSO's drawing of PSC sleepers.

1. All dimensions are in millimeters.
2. The load 'P' will be applied at centre line of Rail Seat through pressure distributing M.S. Plate with 1 in 20 slope and size 145X25mm, covering the full width of sleeper.

3. One rail seat bottom shall be tested at a time. It shall be ensured that the other end is not restrained in upward direction. The rate of loading is 30-40KN per minute.
4. Cracks shall not appear up to the load mentioned in relevant drawings, when retained for three minute.
5. A coat of lime wash shall be applied on the sleeper surface before testing.

FLOW CHART FOR TESTING OF SLEEPER

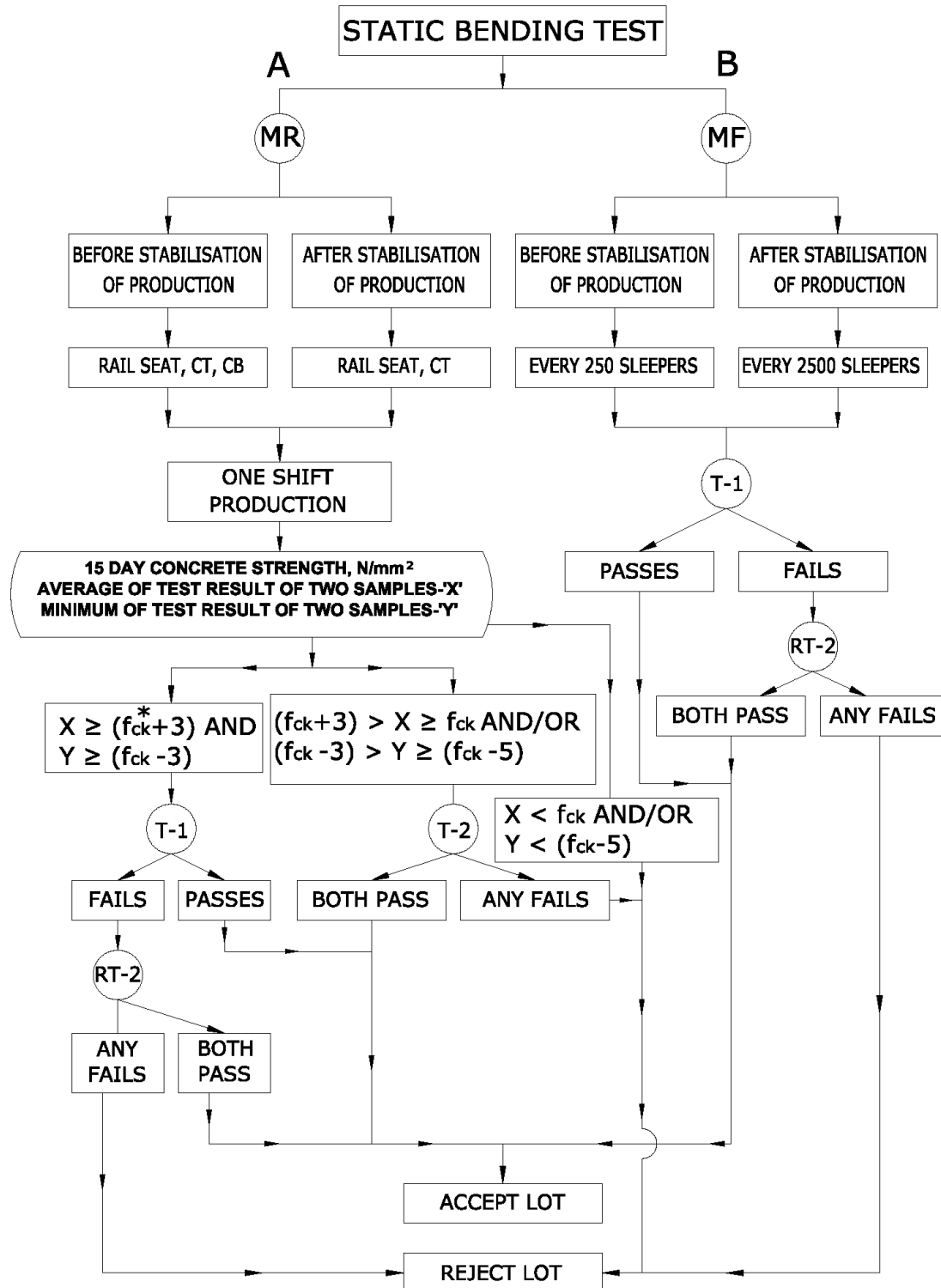

ANNEXURE-IV (Contd.)

NOTATIONS & EXPLANATORY NOTES:

MR: MOMENT OF RESISTANCE TEST:

- RAIL SEAT BOTTOM, CENTRE TOP & CENTRE BOTTOM (PRIOR TO STABILISATION)
- RAIL SEAT BOTTOM & CENTRE TOP (AFTER STABILIZATION)

MF: MOMENT OF FAILURE TEST FOR RAIL SEAT BOTTOM

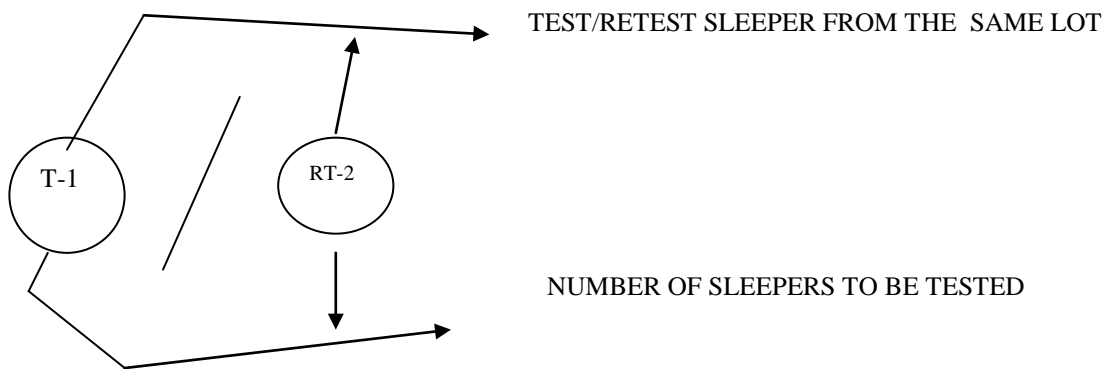

PASSES : SLEEPER PASSES RELEVANT TEST SUCCESSFULLY

FAILS : SLEEPER FAILS IN ANY OF THE RELEVANT TEST

NOTE :

- (1) WHEN DUE, MF TEST SHALL BE CONDUCTED ON THE FIRST SLEEPER SELECTED FOR TESTING UNDER MR
- (2) WHENEVER MF IS DONE, PASSING THIS TEST IS A PREREQUISITE FOR ACCEPTANCE OF THAT LOT UNDER 'A' OF FLOW CHART.
- (3) IF THE FIRST SLEEPER HAS PASSED MF TEST BUT FAILED IN ANY OTHER TEST, MF TEST NEED NOT BE REPEATED ON SUBSEQUENT SLEEPERS SUBJECTED TO RE-TESTING.

ANNEXURE-V

PROCEDURE FOR CHECKING FITNESS OF CONCRETE SLEEPERS ON TRACK CIRCUITED STRETCH (AT THE TIME OF INSPECTION IN THE CONCRETE SLEEPER MANUFACTURER'S PREMISES)

1. All the sleepers shall be tested.
2. The sleeper shall be checked for electrical resistance at 230 volts AC supply. The circuitry to be followed will be shown in sketch at Annexure-V (Contd.).
3. The 230 volts AC supply will be passed through a not less than 300 W test lamp in series with the pairs of inserts being tested. For the sake of comparison, another comparator bulb of the same wattage directly connected to the 230 volts AC supply will be fitted along side.
4. Since the testing is being done at a higher voltage, removal of the rust layer by grinding shall not be necessary.
5. Resistance will be checked against 2 rail seats.
6. If the test lamp emits light dimmer than the comparator lamp in the sleeper, the sleeper shall be accepted and marked 'FTC' (Fit for Track circuit). If it emits light with the same brightness as the comparator lamp, the sleeper will be rejected and marked 'NFTC' (Not fit for track circuit). In case the test lamp does not emit light at all, it indicates that the circuitry is defective and should be rechecked.
7. In the event of doubts regarding comparison of brightness, such sleepers will not be marked. They will be retested with 1.5 V Avometer and marked for fitness, if found fit with 200 ohms resistance.
8. The 'NFTC' marked sleepers should be stacked separately. The FTC/NFTC marking shall be done on top of sleepers in middle portion, as shown on Drawing No.RDSO/T-2466.
9. As the testing is done at higher voltage, all precautions such as use of gloves in the hands, insulated boots and insulated chairs for operator and other necessary precautions shall be taken for the safety purpose.

ELECTRICAL CIRCUIT FOR TESTING
CONCRETE SLEEPER IN PLANT

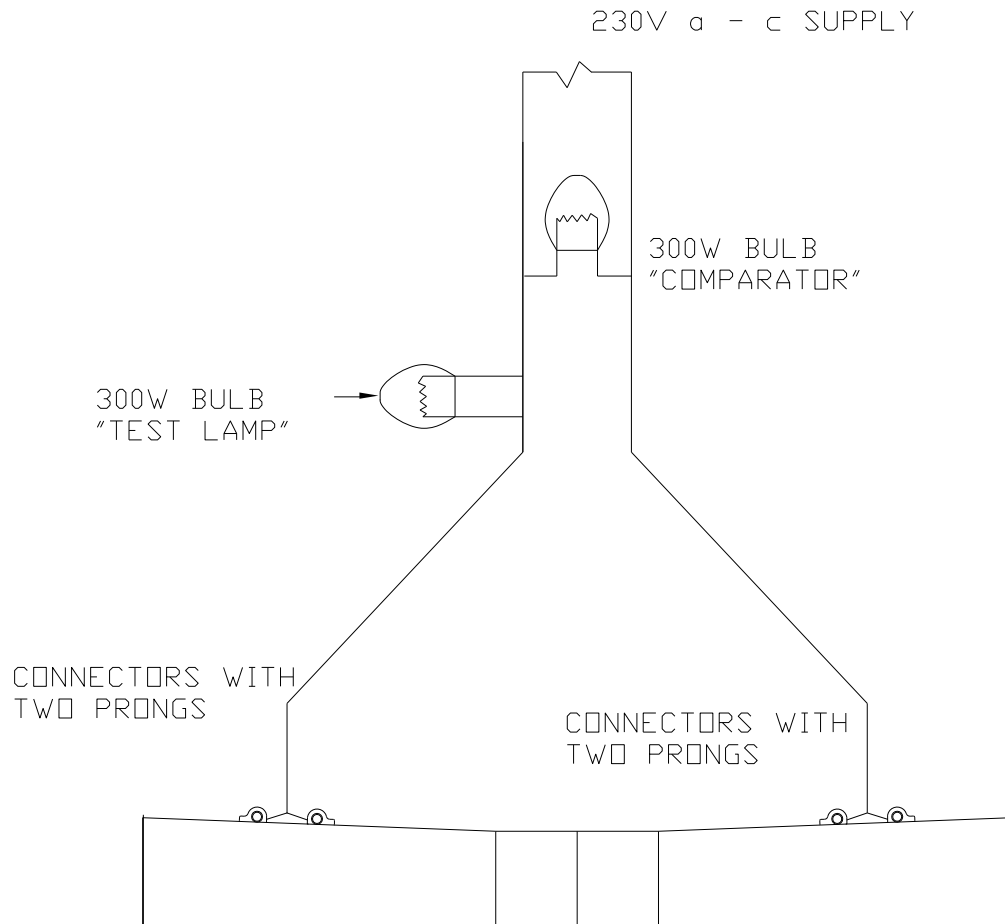

NOTE:

1. THE CONNECTORS SHALL HAVE TWO PRONGS EACH SO THAT BOTH INSERTS AT A RAILSEAT ARE TESTED AT A TIME.
2. NECESSARY PRECAUTIONS FOR WORKERS SAFETY SHALL BE TAKEN.

LIST OF IRS & BIS CODES REFERRED TO

(Up-to-date version of Codes/Specifications with latest amendments/correction slips shall be followed)

S.N o.	IRS/IS No. & Year	Description
1	IS:269-2015	Ordinary Portland Cement- Specification (Sixth Revision)
2	IS:1343 – 2012 (Reaffirmed-2017)	Prestressed Concrete-Code of Practice (Second revision)
3	IS:383 – 2016	Coarse and fine aggregates for concrete-specification (third Revision)
4	IS:456-2000 (Reaffirmed-2016)	Plain and reinforced concrete- code for practice (Fourth Revision)
5	IS:516 – 1959 (Reaffirmed-2018)	Method of test for strength of concrete
6	IS:650 – 1991 (Reaffirmed-2018)	Standard sand for testing of cement (Second Revision)
7	IS:1785 Pt.I - 1983 (Reaffirmed-2018)	Specification for plain hard drawn steel wire for prestressed concrete Part.I Cold drawn stress relieved wire (Second Revision)
8	IS: 2386 - 1963 Pt. I – VIII (Reaffirmed-2016)	Methods of tests for aggregate for concrete
9	IS:2430 –1986 (Reaffirmed-2019)	Methods for sampling of aggregate for concrete(First Revision)
10	IS:2514 – 1963 (Reaffirmed-2017)	Specification for concrete vibrating table
11	IS:3536 - 2016	Ready mix paint, Brushing, Wood primer-Specification (second revision)
12	IS:4031 –(Part-1)- 1996 (Reaffirmed- 2019)	Methods of physical tests for hydraulic cement Part -1 Determination of fineness by dry sieving (Second Revision)
13	IS:4031 (Part 2) - 1999 (Reaffirmed- 2019)	Part-2 Determination of fineness by specific surface by blaine air permeability method (First Revision)
14	IS:4031 (Part 3) - 1988 (Reaffirmed- 2019)	Part-3 Determination of soundness (First Revision)
15	IS:4031 (Part 4) - 1988 (Reaffirmed- 2019)	Part-4 Determination of consistency of standard cement paste (First Revision)
16	IS:4031(Part 5) - 1988 (Reaffirmed- 2019)	Part-5 Determination of initial and final setting times (First Revision)
17	IS:4031 (Part 6) – 1988 (Reaffirmed- 2019)	Part-6 Determination of compressive strength of hydraulic cement (other than masonry cement) (First Revision)

18	IS:4031(Part 14) - 1989 (Reaffirmed-2019)	Part-14 Determination of false set
19	IS:4032 - 1985 (Reaffirmed-2019)	Methods of chemical analysis of hydraulic cement
20	IS:6006 - 2014 (Reaffirmed-2019)	Uncoated stress relieved strand for pre-stressed concrete-Specification (Second Revision)
21	IS:9103 - 1999 (Reaffirmed-2018)	Specification for concrete Admixture
22	IS:10262 - 2019	Concrete Mix Proportioning – Guidelines (Second Revision)
23	IS:2770 (Pt.1)-1967 (Reaffirmed-2017)	Methods of testing bond in reinforced concrete Part 1: Pull-out test
24	IRS/T-46	Specification for Spheroidal Graphite Cast Iron inserts
25	Schedule of Technical Requirement (STR)	Schedule of Technical Requirement for manufacture of PSC Sleepers as applicable from time to time.

**GOVERNMENT OF INDIA
MINISTRY OF RAILWAYS
(RAILWAY BOARD)**

**‘Corrigendum No. 1’ to
‘IRS Specification for PSC Sleepers for Broad Gauge,
Metre Gauge and Narrow Gauge
Serial no. T-39
(Sixth Revision –March 2021)**

The existing clauses 1.0, 3.6.2 (i), 3.7.1, 4.4, 4.5.1 shall be replaced as under and a new Annexure-VII regarding setting up of new concrete sleeper plant (CSP) has been added:

- 1.0 This specification covers the manufacture and supply of pre-tensioned pre-stressed concrete sleepers for broad gauge, metre gauge and narrow gauge. For production of PSC sleepers through long line method, some of the provisions of this Specification may not be implementable. In such cases, manufacturer shall approach RDSO for specific dispensations, wherever required and these dispensations will be considered by Track Design Directorate of RDSO.
- 3.6.2 The concrete shall satisfy the following design parameters:
- i) Minimum release strength after 40 N/sq.mm (For Mix M 55)
steam curing 50 N/sq.mm (For Mix M-60)
- 3.7.1 SGCI inserts shall conform to IRS Specification No.T-46-1996 as amended up-to-date. Each consignment of SGCI inserts shall be accompanied by a test certificate from inspecting agency for inspection conducted prior to dispatch of consignment from supplier’s premises.
- 4.4 **De-tensioning of wires**
- Anchoring system shall provide a device for gradual de-tensioning of the wires. Back pulling of wires for releasing any wedge shall be strictly prohibited. De-tensioning of wires shall be undertaken

only after the concrete has attained a compressive strength of 40 N/sq.mm (For Mix M-55) & 50 N/sq.mm (For Mix M-60)

4.5.1 Initial curing of concrete sleeper shall be done by steam at atmospheric pressure till the concrete attains a compressive strength of 40 N/sq.mm (For Mix M-55) & 50 N/sq.mm (For Mix M-60). Pre-steaming period shall not be less than the initial setting time of cement.

Total steam curing cycle duration can vary from 10 to 12 hours depending on time taken in the steam curing stages e.g. presteaming, temperature rising (heating), constant temperature duration, cooling etc. Total cycle time depends on ambient temperature.

- i) Normal pre-steaming period is recommended as 2 hours or initial setting time (IST) of cement whichever is greater.
- ii) Temperature rising time is recommended as 2.0 to 2.5 hours keeping maximum rate of rise of temperature as 15°C per hour.
- iii) Maximum steam curing temperature shall be not more than 60°C keeping constant temperature in range of 55 – 60°C. Constant temperature duration can be kept between 3.5 to 5.0 hours.
- iv) Cooling of sleepers shall be gradual and cooling period is recommended in range of 2 to 3 hours with cooling rate not exceeding 15°C per hour.

Extra one hour cooling of sleepers at ambient temperature before demoulding is desirable/recommended, if feasible keeping the total cycle time upto 12 hours to minimize difference in external and internal (inside) temperature of sleepers.

Mix design shall be revised, if minimum strength of 40 steam cured cubes is less than 40 N/ sq.mm (For Mix M-55) & 50 N/sq.mm (For Mix M-60) following the above mentioned stipulations on steam curing cycle. The steam curing cycle which is proposed to be adopted shall have prior approval of the inspecting official.

Policy on setting up of New Concrete Sleeper Plant (CSP)

Railway Board's letter no.2004/TK-II/22/11/5 (shifting) dated 19.02.2021

There should not be any approval required from Railway Board for setting up any new Concrete Sleeper plant anywhere in India. However following stipulations are to be fulfilled.

1. Zonal Railways shall be asked to carry out an exercise of availability and requirement/demand of main line PSC concrete sleepers on the Railways every 2 years or as needed. During this exercise, Zonal Railway deficient in sleeper production shall be identified based on the gap between available latest rated capacity of CSPs (as per calculation of RDSO) and average sleeper demand for next 2 years period. An extra margin in sleeper requirement of 30% more than the demand in each zonal railway over next 2 years is proposed to be kept. This extra margin is considered to provide for extra capacity on all zonal railways for ensuring better competition as well as guarding against any sudden spike in demand due to sanction of more projects in a particular year or failure of one or more CSPs. Based on such exercise Zonal Railways shall be asked to submit sleeper demand statements. Only those Zonal Railways will be treated as deficient, which have projected average demand (with 30% extra margin discussed above) for 2 years period, more than the total rated capacity of CSPs in that Zonal Railways. The "Deficient Railway Zones" thus identified shall be advised by Railway Board to RDSO and all Railways for publishing on RDSO's website.
2. Any firm satisfying the qualifying requirements laid down in subsequent paragraphs is allowed to setup new CSP at any location to serve Railway sleepers requirements with an intention of supplying PSC sleepers from a location nearby consumption centers so that the cost of freight of sleepers is limited. Railways will give preference and priority (in terms of giving early inspections and approvals by RDSO) to firms desirous of setting up concrete sleeper plants in deficient Railways as identified in para 1 above. This is done to encourage new

firms to setup concrete sleeper plants in deficient Railways as Railways will gain in terms of lesser freight by setting up of new concrete sleeper plants. However, firms are free to setup concrete sleeper plants anywhere in India without the need of advance approval from Railways.

3. Firms desiring to setup new concrete sleeper plants in either a deficient Railways or any other Railway can submit proposal on a customized RDSO's web-portal (or in offline mode till such time the portal is not operational). The details of deficient Railways also will be available on the website.
4. The Concrete Sleeper plant at the new location should be set up on private land only. Required siding would also have to be developed at firm's cost, however required connectivity from existing railway yard shall be provided as per the extant rules, by the concerned zonal railway.
5. Firms desiring to setup new CSPs have to approach RDSO by application on a customized web-portal (or in offline mode till such time the portal is not operational) for setting up of new CSP along with compliance of latest STR, IR Specification for manufacturing of PSC sleepers, their Quality Assurance Plan (QAP) and layout plan of the proposed CSP. RDSO will scrutinize the proposal and approve for setting up of new CSP first as a Developmental Plant after necessary inspections and scrutiny.
6. Qualifying Requirements:

Firms desiring to setup new CSPs shall fulfill the following eligibility criteria which shall be scrutinized by RDSO:

- (a) The firms should be of sound financial standing and should have a total turnover of at least Rs. 10 crores from all business activities in any of the preceding 3 financial years. In support of financial standing, necessary document as per latest instructions to be submitted.
- (b) The firms shall be financially solvent for at least Rs. 1.50 crores and a certificate to this effect issued by a Scheduled Bank shall be enclosed with the proposal.

7. Other terms and Conditions:

- 7.1 The term new CSP would mean CSP being set up at a new geographic location whether a new plant or a shifted plant. For shifting of concrete sleeper plants within the Zonal Railway, procedure as per Railway Board's letter No. 2004/Track-II/22/11/5 dtd. 22.02.2006 is to be followed.
- 7.2 New CSPs would require to offer sleepers duly loaded in railway wagons from a rail siding. New CSPs are required to develop such sidings at their own cost. Necessary connectivity from an existing yard shall be facilitated as per the extant rules in this regard.
- 7.3 New CSPs to have minimum production capacity of 2.4 lakh PSC BG line sleepers per annum.
- 7.4 Tenders for procurement of PSC mainline sleepers for Indian Railways requirements shall be dealt as per extant policy and instructions.
- 7.5 Once RDSO certification as a developmental CSP is available to a Concrete Sleeper Plant (CSP) for any category of PSC Sleeper, that CSP shall become eligible for all types of concrete sleepers requirements of all Railway zones and these plants are eligible to participate in all sleepers tenders of Railways as Developmental Plants.
- 7.6 After setting up of a new Concrete Sleeper Plant (CSP) at new location, its RDSO certification would be mandatory, to qualify as a Developmental Plant, eligible to participate in sleeper procurement tenders.
- 7.7 During tendering process of mainline PSC sleepers, as the product of New CSPs is not yet tested/proven, these will qualify as Developmental Plants. A suitable initial quantity of PSC sleepers till stabilization of production would have to be passed by RDSO.
- 7.8 Quantity of sleepers allocation on sleeper plants including the developmental plants shall be based on a competitive web based open online tendering process, including electronic reverse auction (e-RA).

- 7.9 RDSO's guidelines for upgradation from Developmental to proven/regular category for all types of PSC sleepers required on Indian Railways, shall be followed.
- 7.10 RDSO shall be certifying all concrete sleeper plants every 2-3 years and only RDSO certified plants will be eligible for supplying sleepers to Indian Railways.
- 7.11 RDSO and Railways may even take help of RITES and accredited third parties approved by National Accreditation Board for Certification Bodies (http://nabcb.qci.org.in/accreditation/reg_bod_fsms.php) for inspection and certification processes, with onus of such inspections/certification from accredited laboratories/third parties on the sleeper manufacturers. Costs for all such quality tests and costs of certifications have to be borne by the concerned CSPs. However, final responsibility of quality and approvals shall rest with the RDSO and Railways only.
- 7.12 Once the Developmental Plants are certified as Proven/Regular/Approved by RDSO based on extant RDSO rules/guidelines, these will become eligible for the bulk/regular orders.

Annexure 2
To Part 2 Supply Requirements

SCHEDULE OF TECHNICAL REQUIREMENT (2023)
FOR
MANUFACTURE OF PSC SLEEPER

DOCUMENT NO.TDG 0046

(JUNE 2023)

**GOVERNMENT OF INDIA
MINISTRY OF RAILWAYS
(RAILWAYBOARD)**

**SCHEDULE OF TECHNICAL
REQUIREMENT (2023) FOR
MANUFACTURE OF PSC SLEEPER**

**DOCUMENT NO.TDG 0046
(JUNE 2023)**

**RESEARCH DESIGNS AND STANDARDS ORGANISATION
LUCKNOW-226011**

**SCHEDULE OF TECHNICAL REQUIREMENT (2023) FOR
MANUFACTURE OF PSC SLEEPER**

DETAILED INFORMATION

1.0 Name of Sleeper Plant:

- a) Location :
- b) Railway :
- c) Nearby Railway Station :
- d) Nearby Main Station :
- e) Distance from Main & Nearby Station :
- f) Telephone / Fax No.
- g) Address :
 - i) Office:
 - ii) Factory :
- h) Details of Production :
 - i) Main Line Sleepers
 - ii) 1 in 8½, Turnout Sleepers
 - iii) 1 in 12, Turnout Sleepers
 - iv) Wider Sleeper
- i) Whether Plant is approved for manufacturing any other type of sleeper:

2.0 Method of manufacture (Long line, Stress bench etc.):

3.0 Contract details:

S.No.	C. A. No.	Railway	Type of sleepers	Quantity	Delivery date

4.0 QUALITY ASSURANCE PLAN & ISO CERTIFICATION:

S No	Item	Remarks
4.0.1	QAP Approved by RDSO (Yes / No)	
4.0.2	Date of approval of QAP by RDSO	
4.0.3	Remarks about implementation of QAP	
4.0.4	Whether Plant is having ISO: 9001-2015 (Yes / No)	
4.0.5	ISO Certifying agency & Date of validity of ISO certificate	
4.0.6	Whether Internal Quality Audit of plant is done by the firm at a frequency of at least once a year.	

5.0 ORGANISATION STRUCTURE:

Typical organization structure chart of a Concrete Sleeper Plant is as given below -

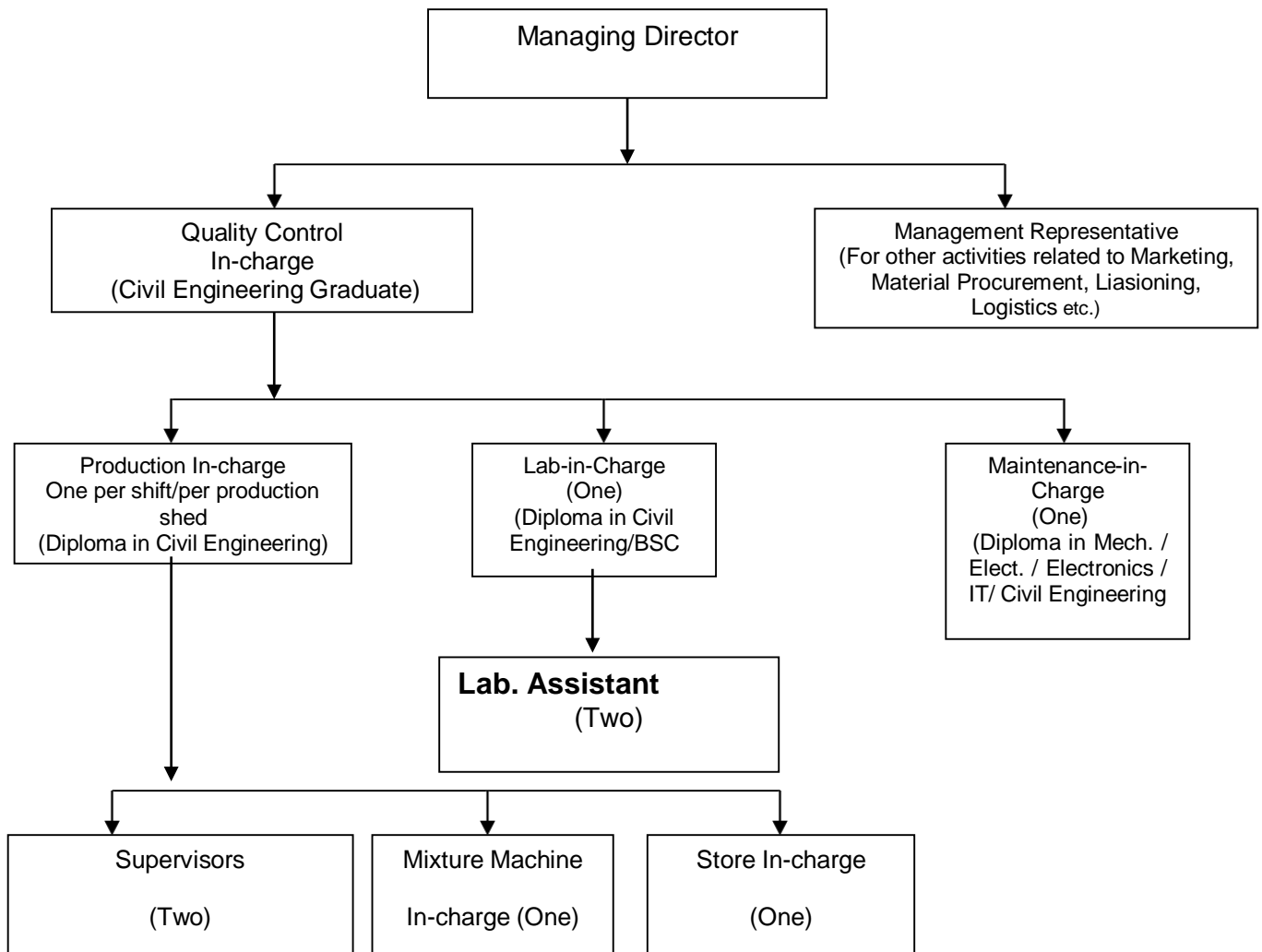

5.1 Minimum Level of Technical Supervision:

1. Overall Quality Control In-charge: At least One Graduate Engineer with Civil Engineering degree.
2. Shift In-charge for Production:
 - (a) Minimum one supervisors with diploma in civil engineering for each shift per each casting shed.
 - (b) Minimum one diploma engineer of mechanical/ electrical / electronic / IT /civil for maintenance of equipments.
3. Quality Control Supervisor for Laboratory and testing: Minimum one supervisor with Diploma in Civil Engg./ BSc .
4. Supervisors & Mixture Machine In-charge should be suitably qualified and their competency shall be certified by the overall Quality Control In-charge of the plant.

5.2 DETAILS FOR LEVEL OF SUPERVISION:

SNo.	Item	Name	Qualification	Experience
5.2.1	Nos. of Engineers			
5.2.2	Nos. of Technical Supervisors			
5.2.3	Name of separate Quality Control Supervisor for Laboratory			
5.2.4	Reason for any deficiency in manpower and planning of compliance.			

6.0 LAYOUT PLAN:

S No.	Item	Remarks
6.0.1	Owner Ship of land/ Lease Agreement with Railway.	
6.0.2	Notarized copy of agreement	
6.0.3	Remarks about deficiency , if any	
6.0.4	Whether Layout plan is fully with in land owned by plant and there is no unauthorized construction on railway property.	
6.0.5	Whether Layout plan is approved if yes then details of approving authority & reference	

6.1 LAYOUT REQUIREMENT:

S.No.	Item	Minimum Requirement	Existing	Remarks
6.1.1	Cement Godown	Min. covered godown area = 400 sq.m. (Storage as per IS:4082- 1996)		
6.1.2	HTS Storage	Minimum area of covered godown with EOT for handling of HTS wire coils= 100 Sqm.		
6.1.3	Insert Godown	Minimum Area of covered godown = 100 sqm.		
6.1.4	Steam curing chambers	Minimum no. of chamber = $(0.65*N/32)$ rounded off to next whole number, where 'N' is the proposed daily production capacity. Chambers shall be vertical type with continuous digital temperature recording facility connected with storage of data with servo control automatic steam control arrangement. CSPs having present arrangement of Horizontal steam chamber may continue with existing arrangement.		
6.1.5	Submerged water curing tanks	Minimum Submerged water curing capacity required (In no of sleeper) = $(0.65 \text{ to } 0.75)*N$ Where, 'N' is monthly production capacity. Capacity of one tank should be maximum 3 days production. Tank should have minimum 30 cm free board.		
6.1.6	Stacking Area for finished sleeper	Minimum 2 month capacity. Maximum layers of sleepers in one stack should be 25. Minimum area= $0.08*N$ sqm. Where N is monthly production capacity.		
6.1.7	Laboratory	General : Approximately 40 sqm Sleeper testing area : Approx. 30 sqm. The laboratory and sleeper testing area should be illuminated should have 100% power backup. The laboratory shall be provided with adequate air conditioners for temperature and humidity control.		
6.1.8	Inspecting Officials office	Minimum 14 sqm. Fully furnished with adequate communication facilities (Fax, Telephone, Computer with net connectivity etc)		
6.1.9	Rest House	Minimum two room sets fully furnished with attached toilet and other amenities including cooking facility. Min. area 25 sqm.		
6.1.10	Platform for turnout sleepers	At least two platforms of 70mx6m with gantry arrangement for handling for inspection of two sets at a time.		

7.0 Minimum requirement of Plant and Machinery for Concrete Sleeper Plant: Production Line

S. No.	Particulars	Qty.
7.1	General	
7.1.1	Concrete mixer along with Automatic Batching Plant using Microprocessor based Weigh Batcher, Pneumatically operated Aggregate Bins, Water meter and automatic Cement feeding, Capacity of Concrete 5m ³ /hr. It should be capable of keeping digital record of ingredients used batch wise & data storage capability for one year production and should be capable of providing output in hard copy also.	1 no.
7.1.2	Standard weights of 50 Kg or highest permissible denomination totaling 50kg & Small denominations capable of measurement to the least count of 1 kg for calibration of weigh batcher	1000 Kg
7.1.3	Water measuring cans or automatic water meter for calibration of water meter	1,2,5,10&20 liters
7.1.4	Concrete sleeper Mould should be made with plate thickness 6/8mm with suitable stiffening arrangement to avoid in service distortion of moulds. Rail seat area & end plates are to be made with 10 mm thick Steel plate. Rail seat area should also be made with adequate measures to ensure proper rail seat slope and surface finish. *Minimum for a monthly production capacity of 5000 nos assuming one shift per day (For higher production capacity no of mould required for daily production plus 20 % for maintenance purpose.)	240 nos.*
7.1.5	Laser based continuous profile measurement system for checking critical dimensions of PSC sleeper	As per production requirement subject to minimum 1 no.
7.1.6	Steam Boiler, Coal /oil fired/electrically operated capacity of 1000 kg/hr, complete with Valves, mountings and Chimney. The key parameters of boiler such as steam pressure should be displayed. The boiler & its operators certification from statutory authority should be ensured.	1 no.
7.1.7	Double Acting Hydraulic Jacks 1000KN Capacity	4 nos.
7.1.8	Concrete Bucket for carrying and pouring concrete in moulds by bottom controlled discharge on Monorail Hoist, Movement should be motorized and operator controlled.	1 no.
7.1.9	High Frequency 9000 RPM (+/-4%) Vibrator arrangement bottom fixing type. For PSC line sleepers and Turnout sleepers, vibrators of min 2.0KW capacity are to be used. The vibrator should have recording facility for recording date and time of each operation. RPM should be digitally displayed during operation. Fixing arrangement of Vibrator to the bottom of moulds should be effective enough to transfer the vibrations.	16 nos.
7.1.10	Tachometer 10000 RPM capacity	2nos

7.1.11	High Frequency Converter for Vibrators	2 nos.
7.1.12	Vibrating Table for Cubes 15X 15 X 15, table 1mX 1m	1 no.
7.1.13	Electric Welding Arc Cutting M/c for HTS cutting at de-molding/ Abrasive disc cutter.	2 nos.
7.1.14	Trolley for transportation of Finished Sleeper	10 nos.
7.1.15	Overhead Wire Rope Hoist 2 T capacity, Electrically driven, traveling on I Beam Section, One each for demoulding and curing tank	2 nos.
7.1.16	Overhead Wire Rope Hoist for Steam Curing Chambers 3 T capacity, traveling on IBeam Section (Excluding the structure)	2 nos.
7.1.17	MS Gantry Crane electrically driven with Overhead Wire Rope Hoist 4/5 T capacity for Loading of sleepers and for putting sleepers in water curing tanks.	2 nos.
7.1.18	Diesel Generating Set for 125KVA	1 no.
7.1.19	Workshop Equipments <ul style="list-style-type: none"> • Lathe Machine • Tower Drilling Machine • AG-7 Angle Grinder • Electric Welding Set • Gas cutting Set • Misc. tools and dies • Misc. measuring tapes, scales 	At least one each.
7.2	For Production by Stress Bench Method	
7.2.1	Steel Stress Benches made of channel and with Jack Anchoring Pockets, for holding 4 sleeper moulds. Design of stress bench should be such so as to have minimum distortion on account of service stresses. *For a monthly production capacity of 5000 nos BG Line sleepers assuming one shift per day however it may be increased in the multiples of the required production capacity.	60 nos.*
7.2.2	Hydraulically operated Pre-Stress Equipment with motorized unit, for 500KN jacks along with Pressure Gauges / pressure transducer with digital display and auto cut arrangement. The data should be displayed on monitor and should be stored for future analysis of past six months data.	2 Sets
7.2.3	Roller and Roller Stand	As per requirement
7.2.4	Trolleys for Transportation of stress benches	6 nos.
7.2.5	Steam curing chamber of adequate size and capacity to hold not more than eight benches containing four moulds each. Provision should be made for perforated pipes of adequate dia., in the steam chamber, for uniform distribution of steam. The steam curing should be with servo controlled valve with steam regulation with auto cut off arrangement following the steam curing cycle. The thermometers should be provided at both ends of steam chamber with digital display. The data of time v/s temperature in each chamber should be digitally displayed and stored and system should have sufficient memory to	

	store at least on year's data with facility to take out print shift wise.	
7.2.6	Pneumatic/Hydraulically operated tensioning gun with upto 2 KN load capacity or similar mechanized arrangement, for initial pulling of individual HTS strands so as to ensure uniform pulling of HTS strands.	02 nos.
7.2.7	Fixture for Insert pocket with rubber lining for holding the insert in fixed position in the mould and for easy demoulding & prevention of slurry leakage.(for stress bench and long line method both)	As per nos. of moulds
7.3	For Production by long line method	
7.3.1	End support embedded in ground with device permitting transfer of pre stress	As per design
7.3.2	Tensioning gun with digital pressure gauge, automatic cut off device and automatic elongation & force recording arrangement along with digital display and logging of data on computer with data storage & retrieval for at least six month.	02 nos
7.3.3	Casting bed with moulds. No of moulds should be 10 % more than required for daily production capacity.	As per design
7.3.4	Tarpaulin hoods for covering casting beds for steam curing. With proper drainage arrangement.	For each casting line
7.3.5	The steam curing should be regulated through servo controlled valve with auto cut off arrangement and regulation of steam to maintain the temperature as per steam curing cycle. The data of time vs temperature covering complete casting line should be digitally displayed and stored. The system should have sufficient memory to store at least on year's data with facility to take out print shift wise.	For each casting line

8.0 Laboratory Equipments:

S. No	Equipment	Quantity
8.0.1	Compression Testing Machine, 2000KN capacity, motorized with 2 nos. of pressure gauges (2000KN & 500KN) with digital interface for real time recording of testing results. The system should have sufficient memory to store data of one year production with reporting facility in hard copy as per format mutually agreed.	1 no.
8.0.2	Flexural Beam (Tension) Testing Machine with loading Jacks, 30 KN capacity. The machine should be capable of digital display and recording of data during testing with auto logging off time & date of testing. Data storage & retrieval capability should be for one year production.	1 no.
8.0.3	Motorized pumping unit with 1000KN capacity jacks, pressure gauge, rubber tubes and test frame complete for sleeper testing. The digital display of the load applied should be visible to observer simultaneously along with observation of crack. The data shall be recorded in computer with automatic date and time record with Batch no. and other details for traceability of record.	1 no.
8.0.4	15 cm cubes moulds conforming to IS:516	50 nos.
8.0.5	Beam moulds 10 x 10 x 50 cm size	2nos.
8.0.6	Slump Tester/Vee Bee Testing Machine	1 no.
8.0.7	Compaction Factor test Apparatus	1 no.
8.0.8	Electronic balance with 1gm least count (10 / 20 Kg. capacity) including weights.	1 no.

8.0.9	Blain's air permeability apparatus	1 no.
8.0.10	Vicat apparatus with dash pot and various needles	1 no.
8.0.11	Stop watch	1 no.
8.0.12	Le Chatelier mould for soundness test of cement	1 no.
8.0.13	Steel trowels for mixing cement paste	2nos.
8.0.14	Cement mortar cube casting machine with motor and time switch complete	1no.
8.0.15	7.06 cm (50 cm ²)mortar cube moulds	2nos.
8.0.16	Metallic scoop, pan type container and china tray etc	2 sets
8.0.17	Aggregate Impact testing machine	1no.
8.0.18	Aggregate crushing testing machine	1no.
8.0.19	Aggregate Abrasion testing machine	1no.
8.0.20	Electric thermostatic oven with display of temperature	1no.
8.0.21	Set of IS Sieves 40 mm and below up to 75 micron	1no.
8.0.22	Automatic electric sieve shaker	1no.
8.0.23	Proving rings of 2000 KN,1000 KN, 500 KN, and 100 KN capacity	1 each
8.0.24	1.5 Volt AVO meter	1no.
8.0.25	Glass cylinders and Beakers 50 - 500 cc capacity	1 set
8.0.26	Miscellaneous measuring gadgets like steel tape, Vernier, filler gauge etc.	2 sets
8.0.27	Inspection gauges for dimension checking of sleepers with digital display of parameters as approved by RDSO. (Optional)	2 sets
8.0.28	Master gauges for checking inspection gauges	1 set
8.0.29	Magnifying glass	1no.
8.0.30	Level table steel for checking gauges	1no.
8.0.31	pH meter & TDS meter (Digital)	1no.
8.0.32	Elongation and Flakiness Index Gauges	1 each

9.0 Requirement of IP based CCTV camera and sensors

- 9.1 IP based CCTV camera monitoring system for remote monitoring of sleeper production in CSPs of Zonal Railways. The live feed from these cameras installed at various critical locations (as given in the table below) shall be provided to concerned Zonal Railways and RDSO.
- 9.2 Installation of Sensors to automatically measure and record various parameters of design mix such as w/c ratio, moisture content of aggregates etc. production process such as stressing, vibration, curing, etc. and testing parameters such as cube strength, SBT test etc. and to automatically transmit these parameters to Zonal headquarter continuously.

9.3 Minimum requirement of IP based CCT camera and sensors

S. No.	ITEM	Minimum Requirement		REMARKS
		CAMERA	SENSORS	
A	STORAGE OF RAW MATERIALS			
1	Cement Godown	2	-	-
2	HTS Storage Area	1	-	Only 1 camera can be provided if HTS storage & Insert storage area are at same location and can be covered by one camera properly.
3	Insert Storage Area	1	-	
4	Coarse Aggregate Storage Area	1	-	
5	Fine Aggregate Storage Area	1	-	Only 1 camera can be provided if CA & FA storage area are at same location and can be covered by one camera properly.
6	Admixture Storage Area	1	-	
B	CONCRETE PRODUCTION			Sensor based mechanism system should be provided to remotely record and report weight of every ingredient of concrete in each batch of concrete.
1	Batching Plant Operator	1	-	-
2	Coarse Aggregate CA-1	1	1	Only 1 camera can be provided if CA & FA storage bins can be covered by one camera properly. One Sensor each for testing moisture content in each storage bin.
3	Coarse Aggregate CA-2	1	1	
4	Fine Aggregate (FA)	1	1	
5	Mixing of Concrete and output	1	-	-
C	SLEEPER PRODUCTION			
1	Production line for concreting	4	1	It should adequately cover the Sleeper casting, Mould preparation and HTS wire threading activities. One sensor for bench counting
2	Extension of HTS wires	1	1	One sensor for measuring extension of HTS wires
3	Application of Load for stressing of HTS Strands	1	-	-
4	Compaction of concrete / Vibration		1	One sensor per vibrator to measure RPM of vibrator and time of vibration.
5	Casting of concrete cubes / vibrating table	1	1	-
D	CURING			
1	Steam Curing Chamber	2	1	Minimum 2 cameras for covering entire steam curing area. One Sensor per Chamber to be

				provided. Temperature of steam curing and steam characteristics to be measured and to be captured in the overall system being used at the centralized location.
2	Water Curing	4	-	Minimum 4 cameras for covering entire water curing area.
3	De-tensioning and de-moulding area	2	-	Only 1 camera can be provided if both operations are at same location and can be covered by one camera properly.
E	TESTING LABORATORY			
1	Concrete Cube Testing	1	1	Only 1 camera can be provided if Concrete Cube Testing and Beam Testing are done at same location and can be covered by one camera properly.
2	Beam Testing	1	1	
3	Static Bending Test	1	1	-
4	Testing of various ingredients of concrete viz. Fine Aggregate, Coarse Aggregate, Cement Water, Admixture etc.	1	-	Should cover entire lab activities.
F	TURNOUT ASSEMBLY AREA	2	-	-
				-
G	STACKING AREA	4	-	-
				-
H	OTHERS	2	-	Entrance/Exit etc.
Note: The IP based CCTV cameras should be of high resolution and sensors should be of high sensitivity.				

CERTIFICATE

1. This is to certify that the information submitted in Paras 1 to 9 above is correct.
2. Testing of raw material shall be carried out as per relevant specifications, the details of raw material used is as given in as Annexure-I.
3. Record shall be maintained as per periodicity mentioned in annexure-II and on formats mentioned therein.

SIGNATURE OF PROPRIETOR

NAME & SEAL

Annexure-I

1.0 Raw material details & Source of raw materials

S No.	Items	Remarks
1.0.1	Cement (Brand name)	
	Location of cement plant	
1.0.2	HTS wire (BIS approved source)	
	Validity of BIS approval	
1.0.3	6 mm MS Bar (confirming to IS: 2265)	
1.0.4	Quarry name for CA1	
	Distance of quarry from the plant	
1.0.5	Quarry name for CA2	
	Distance of quarry from the plant	
1.0.6	Source name of Fine aggregate	
	Distance of source from the plant	
1.0.7	SGCI Inserts Source	
1.0.8	HDPE Dowel Source	
1.0.9	Water source	
	Quality and quantity	
1.0.10	Details of Admixture being used	

2.0 Characteristics of raw materials:

2.1 Coarse Aggregate (as per test report submitted at the time of approval of mix design)

S No.	Item	Coarse aggregates, CA1	Coarse aggregates, CA2
2.1.1	Specific gravity		
2.1.2	Impact Value		
2.1.3	Abrasion Value		
2.1.4	Crushing Value		
2.1.5	Combined Flakiness & Elongation Index		
2.1.6	Water absorption		

2.2 Fine Aggregate (as per test report submitted at the time of approval of mix design)

S No.	Item	Fine aggregate river sand	Fine aggregate crushed stone
2.2.1	Specific gravity		
2.2.2	Silt content		
2.2.3	Deleterious materials		
2.2.4	Zone		
2.2.5	Water absorption		

2.3 High Tensile Steel

S No.	Item	Remarks
2.3.1	Conforming to IS: 6006 specification	
2.3.2	Type (Plain, Strand): Nominal diameter	
2.3.3	Breaking Load & Elongation	
2.3.4	0.2% Proof Stress	
2.3.5	Young Modulus	

2.4 Water

S No.	Item	Remarks
2.4.1	Testing agency (Copy to be enclosed)	
2.4.2	pH value =	
2.4.2	Chloride content (mg/lit) =	
2.4.2	Sulphate content (mg/lit) =	
2.4.2	Inorganic Solids (mg/lit) =	
2.4.2	Organic Solids (mg/lit) =	
2.4.2	Suspended Solids (mg/lit) =	

2.5 SGCI Inserts

S No.	Items	Remarks
2.5.1	Name of Suppliers	
2.5.2	Cross check Heat nos. with IC issued by purchaser / Inspection authority	
2.5.3	BHN value =	
2.5.4	Phosphorous content (%) =	
2.5.5	Condition of storage in general	

2.6 6 mm M S Bar

S No.	Item	Remarks
2.6.1	Conforming to IS: 226	
2.6.2	Nominal diameter	
2.6.3	Breaking Load & Elongation	
2.6.4	Yielding stress	

2.7 Admixture

S No.	Items	Remarks
2.7.1	Conforming to IS:	
2.7.2	Properties	

Annexure-II**MAINTENANCE OF RECORDS AND DOCUMENTATION :**

Following records shall be maintained for scrutiny at future dates.

1.0 Inventory of Raw materials:**1.1 Aggregates:**

- a) Coarse Aggregate (CA₁) 20 to 10 mm
- b) Coarse Aggregate (CA₂) 10 mm and down.
- c) Fine Aggregate (River Sand & Crushed Stone sand)

Details of Receipt, Source, Date of receipt, Truck Nos., Quantity, Balance, Remarks about quality and signature.

1.2 H.T.S. (IS: 6006) :

Date of Receipt, Truck No., Nos. of Coils, Serial No. of each coil, Source (Name of the firm), Details of test certificate, quantity, shift-wise consumption, balance and remarks whether test certificate is OK. Each lot shall bear a lot number and it should be mentioned in the production register to correlate, which HTS used in which sleeper.

1.3 Special Cement (IS 269):

Date of receipt, Source, quantity, Shift-wise consumption, balance, whether Test Certificate received, Details of Lab Tests done at site, Consistency, Initial & Final setting time, Fineness and 7 days mortar cube strength. Each lot shall bear a lot number and it should be mentioned in the production register to correlate which cement used in which sleeper.

1.4 Inserts (IRS: T- 46) :

Date of Receipt, Truck No., Quantity, Source (Name of manufacturer), Consumption, Balance etc shall be recorded. Each lot shall bear a lot number and it should be mentioned in the production register to correlate which insert used in which sleeper.

1.5 Admixture (IS 9103):

Date of receipt, Source & conformance to IS codes, quantity, Shift-wise consumption, balance, whether Test Certificate received shall be recorded. Each lot shall bear a lot number and it should be mentioned in the production register to correlate with production of PSC sleepers.

2.0 Production Records:

2.1 Production Register: Batch Nos., Nos. Cast in each shift, cumulative production, Bench Nos., Cubes and sleeper testing details, Summary of Rejected and Usable sleepers shall be recorded in the printed register Daily production register shall be maintained for each design of sleepers separately (As per format no. XIV).

2.2 Tension Register: (As per format no. XII).

2.3 Steam Curing Records: (As per format no. XIII).

3.0 Testing Records:

- a) Sieve analysis with combined granulometric analysis of aggregates. (As per format no. VI).
- b) Combined Flakiness and Elongation indices test. (As per format no. VII).
- c) Moisture content and modified (adjusted) quantities. (As per format no. V).
- d) Records of Moulds and Benches and repairs.

- e) Details of Pressure Gauges, Proving Rings and calibration of Pressure gauges.
- f) Steam curing and Release cube testing.
- g) Dimensional checking. (As per format no. XV).
- h) Proforma for individual batch production records.
- i) Proforma for monthly progress Report.
- j) Standard deviation and characteristic strength of
 - ii) Release cubes.
 - iii) 15 days water cured cubes.
 - iv) Sleeper cracking loads / Rail Seat bottom and center top.
- k) Dispatch Register.

4.0 Statistical Analysis & Report to RDSO:

Statistical analysis along with calculations shall be submitted to RDSO every month in Format-XVII. The statistical analysis should be carried out for following parameters –

- i) Release cube strength
- ii) 15 days water cured cube strength
- iii) Flexural Beam strength
- iv) SBT results

Similar analysis shall be carried out for each month and a consolidated report shall be submitted for a given financial year.

5.0 Calibration records:

The record shall be maintained as per Format-IX, X & XI for calibration of weigh batcher, Water meter, SBT machine, Concrete cube test machine, cement mortar cube testing machine, Beam testing machine and tensioning jacks. The schedule is given in Para 6.0 below.

6.0 CALIBRATION SCHEDULE:

Calibration of all the pressure gauges shall be done in the plant itself. Calibration of proving ring should be got done from a Govt. approved test house or a National Test House. The frequencies of all the pressure gauges and equipments are as follows:-

S. N.	Equipment	Frequency (For Normal PSC sleeper)	Frequency (For Turnout sleeper)
1	15 cm concrete cube testing machine (2000 KNCapacity)	As per Annexure-I of IRS/T-39	As per Annexure-I of IRS/T-39
2	Cement mortar cube testing machine (500 KNCapacity)		
3	Sleeper static Bend Test machine sleepers (1000 KN Capacity)		
4	Pre tensioning Jacks (500 KN capacity for single mould bench) & (1000 KN Capacity for twin mould bench)		
5	Pre- tensioning Jacks (1000 KN Capacity)		
6	Pre- tensioning Load cell		
7	Concrete beam testing machine (100 KN Capacity)		
8	Aggregate weigh batcher		
9	Cement Weighing Equipment		
10	Water Meter		
11	Admixture Dispenser		
12	Master gauges for checking correctness of dimensions measuring gauges.		
13	Dimension checking gauges.		
14	Proving Rings (All the Four-2000 KN, 1000 KN,500 KN, 100 KN)		
15	Weights & measures		
16	Tachometer		

Note :-

- 1) The items referred at S. Nos. 1 to 7 above should be calibrated by proving ring the sleeper plant itself.
 - 2) The items referred at S. Nos. 8 & 9 should be calibrated by the dead weights and item at S. No. 9 10 by measuring cans that should be available in the plant.
 - 3) The proving ring should be calibrated from a reputed organization like the IITs, NCCBM or NPL etc.
 - 4) The record of calibration of the all the above equipments should be maintained in a manner that previous record can be easily connected.
 - 5) The calibration can be done more frequently at the discretion of the inspecting Official.
-

This is to certify that the information given as above is correct and If the information is found to be false then the firm will accept the action taken by Railway.

SIGNATURE OF PROPRIETER

NAME

SEAL

Annexure III

FORMATS

This section contains different formats of recording results of various testing /measurements prescribed. The firm should have sufficient no of serially numbered Registers printed for each format at all times. The formats should only be filled up by the minimum authority mentioned in QAP. The relevant pages of registers pertaining to production of sleepers being inspected must be scrutinized and signed by Railway official responsible for inspecting the sleepers. In addition to following formats Registers required as per contract condition including Site order register, Officer's Inspection Register and Over Sight Inspection compliance Register should be promptly filled up and presented to Railway Officials during inspection.

SPECIFIC SURFACE OF SPECIAL CEMENT
WITH THE HELP OF BLAINE'S AIR PERMEABILITY APPARATUS

[IS: 4031 (Part-II) -1999]

Date:

Consignment of Cement = _____

Room Temperature = _____ °C

Weight of Sample taken = _____ gms.

Liquid falling time of standard cement (Ts) = _____ Seconds

Specific surface of the standard cement (Fs) = _____ cm² / gm

S. No.	Liquid falling time of sample cement	Average Time (T)	Remarks
1.			
2.			
3.			

Specific Surface of sample Cement (Fm) = $F_s \times \sqrt{\frac{T}{T_s}}$ cm² / gm

= _____ cm²/gm

∴ Specific Surface = _____ cm²/gm

> 3700 cm² / gm. OK / < 3700 cm² / gm. NOT OK

Signature of Railway Inspector
Name
Designation

Signature of Lab In charge
Name

Countersigned by AEN/XEN/CSP
Name
Designation

Format -II

NORMAL CONSISTENCY OF SPECIAL CEMENT FOR INITIAL AND FINAL SETTING TIME

[IS: 4031(Part-III & Part-IV) -1988]

Date:

Consignment of Cement : _____

Room Temperature : _____ °C

Weight of Sample taken = _____ gms

S. No.	% of Water added	Volume of Water added in ml.	Time of adding water	Reading Time	Needle reading in mm from bottom of the mould	Normal consistency % (Minimum)	Remarks
1.							Needle reading between 5 to 7 mm from bottom of the mould indicates Normal Consistency.
2.							
3.							
4.							

∴ Normal Consistency = _____ %

Quantity of water to be added for making paste of special cement for determination of initial and final setting time is 85 % of the normal consistency.

∴ Quantity of water to be added = 85 % of _____ ml = _____ ml.

Signature of Railway Inspector
Name
Designation

Signature of Lab In charge
Name

Countersigned by AEN/XEN/CSP
Name
Designation

Format -III**INITIAL AND FINAL SETTING OF SPECIAL CEMENT**

[IS: 4031 (Part-V) -1988]

Date:

Consignment of Cement = _____

Room Temperature = _____ °C

i. **Weight of sample taken** = _____ **gms**

Normal consistency	=	_____ %
Quantity of water added	=	_____ ml
Time of adding water	=	_____ minutes
Mould ready for needling at	=	_____

S. No.	Reading Time at	Reading of needle from bottom of the mould in mm	Spot of needle for final setting time	Remarks
1.				Initial Setting Time is _____ minutes. > 60 minutes OK < 60 minutes NOT OK
2.				
3.				
4.				
5.				
6.				
7.				
8.				

9.				Final Setting Time is_____minutes. < 600 minutes OK > 600 minutes NOT OK
10				
11				
12				
13				
14				
15				
16				
17				
18				
19				
20				

Initial Setting Time =_____minutes

Final Setting Time =_____minutes

Signature of Railway Inspector
Name
Designation

Signature of Lab In charge
Name

Countersigned by AEN/XEN/CSP
Name
Designation

Format -IV

**7 DAYS COMPRESSIVE STRENGTH OF
CEMENT MORTAR CUBES WITH STANDARD SAND**

[IS: 4031(Part - VI) -1988]

&

SOUNDNESS OF CEMENT [IS: 4031-1988] (Part-III)

Date:

A: 7 Days Compressive Strength of Cement Mortar Cubes with Standard Cement

Consignment of Cement: _____

Room Temperature : _____ °C

ii.

Normal Consistency (P) : _____ % (See Normal Consistency test)

(i) Standard sand = 600 gms.
(3 parts, one part of each grade)

(ii) Cement 1 part = _____ 200 gms.

Total = _____ 800 gms.

∴ Water required for the preparation of mortar cubes in ml.

$$= \frac{(P + 3) \times \text{total weight of sample}}{4}$$

$$= \frac{(P + 3) \times 800}{4}$$

$$= \text{_____ ml}$$

S. No.	Mortar cube casting		Mortar cube testing		Load In KN	Strength in N/mm ²	Minimum Strength in N/mm ²	Remarks
	Date	Time	Date	Time				
1								< 37.5 N/mm ² NOT OK > 37.5 N/mm ² OK.
2								
3								
4								

B: Soundness of cement

Expansion of Le Chatelier apparatus needles -----(not more than 5 mm)

Signature of Railway Inspector
Name
Designation

Signature of Lab In charge
Name

Countersigned by AEN/XEN/CSP
Name
Designation

FORMAT -V**MOISTURE ANALYSIS [IS: 383-2016]****Date****Shift**

S. No.	Description	Units	CA ₁	CA ₂	FA	Remarks
A.	Wt. of wet Sample	Gms.				
B.	Wt. of dried Sample	Gms.				
C.	Wt. of Moisture Sample (A - B)	%				
D.	Moisture = C x 100/B	%				
E.	Absorption	%				
F.	Free Moisture = (D - E)	%				
G.	Batch wt. (Dry)	Kgs.				
H.	Free Moisture = G x F/100	Kgs.				
	Adjusted wt. = (G + H)	Kgs.				
	Wt. Adopted	Kgs.				

W/C Ratio =

A/C Ratio =

If aggregates are wet, moisture content in coarse and fine aggregate is to be accounted for, so as to have total water as per approved mix design.

Signature of Railway Inspector
Name
Designation

Signature of Lab In charge
Name

Countersigned by AEN/XEN/CSP
Name
Designation

FORMAT -VI

COMBINED GRANULOMETRIC CURVE (M55/M60) [IS: 383-2016]

Date		Time				Next Due on												
Sieve Size		Wt. of CA ₁ (20 mm) = gms.				Wt. of CA ₂ (10 mm) = gms.				Wt. of FA (Sand) = gms.				Combined Passing			Combined Passing %	Grading Range
		Wt. Retained grams	Cum. Wt. Retained	Cum. % retained	% Passing	Wt. Retained	Cum. Wt. Retained	Cum. % retained	% Passing	Wt. Retained	Cum. Wt. Retained	Cum. % retained	% Passing	CA ₁ %	CA ₂ %	FA %		
		1	2	3	4	5	6	7	8	9	10	11	12	13	14	15	16	17
20 mm																		
10 mm																		
4.75 mm																		
2.36 mm																		
1.18 mm																		
600 μ																		
300 μ																		
150 μ																		

Signature of Railway Inspector Name Designation	Signature of Lab In charge Name
Countersigned by AEN/XEN/CSP Name Designation	

Format -VII

A. COMBINED FLAKINESS AND ELONGATION INDEX OF 20 MM AGGREGATE (IS: 383, 2016, CL:5.3) & (IS:2386, PART-1)					
IS SIEVE		FLAKINESS INDEX		ELONGATION INDEX	
Passing through 20 Sieve(mm)	Retained on IS Sieve(mm)	Wt. of sample taken (At least 200 pieces) (A)	Weight of passed material on thickness gauge (B)	Wt. Retained material on Thickness gauge (C)=A-B	Wt. of Retained material on gauge (D)
20	16				
16	12.5				
12.5	10				
TOTAL					
Combined Flakiness and Elongation Index= $\{(B/A)+\{D/C\}\} \times 100$ %					
Combined Flakiness and Elongation Index					<40% (ok)

B. COMBINED FLAKINESS AND ELONGATION INDEX OF 10 MM AGGREGATE (IS: 383, 2016, CL:5.3) & (IS:2386, PART-1)					
IS SIEVE		FLAKINESS INDEX		ELONGATION INDEX	
Passing through 20 Sieve(mm)	Retained on IS Sieve(mm)	Wt. of sample taken (At least 200 pieces) (A)	Weight of passed material on thickness gauge (B)	Wt. Retained material on Thickness gauge (C)=A-B	Wt. Retained material on gauge (D)
12.5	10				
10	6.3				
TOTAL					
Combined Flakiness and Elongation Index= $\{(B/A)+\{D/C\}\} \times 100$ %					
Combined Flakiness and Elongation Index					<40% (ok)

As per IRS-T-39 the above result of combined flakiness and elongation Index is less than 40 %.

Signature of Railway Inspector
Name
Designation

Signature of Lab In charge
Name

Countersigned by
AEN/XEN/CSPName
Designation

Format -VIII**A: DETERMINATION OF CRUSHING VALUE [IS :2386 (Part -IV) – 1963]**

Aggregate crushing value = $(B/A) \times 100$

Where B= Weight of fraction passing appropriate sieve,

A= Weight of surface dry sample, when carried out as per provision of para :
2.4 IS 2386 (pt.IV)

- Note:** 1. For aggregates passing through 20mm sieve, 3.35mm sieve size for separating finer to be used.
2. For aggregates passing through 10mm sieve, 1.70mm sieve size for separating finer to be used.

B: DETERMINATION OF IMPACT VALUE [IS: 2386 (Part-IV) -1963]

Aggregate crushing value= $(B/A) \times 100$

Where, B= Weight of fraction passing 2.36mm IS sieve,

A= Weight of oven dry sample, when carried out as per provision of para: 4.4
IS:2386(Pt. IV)

C: DETERMINATION OF ABRASION VALUE [IS: 2386 (Part-IV) -1963]

Aggregate crushing value= $(B/A) \times 100$

Where, B= Weight of fraction passing 1.7mm IS sieve,

A= Weight of oven dry sample, when carried out as per provision of para: 5.2 of
IS:2386(Pt. IV)

Signature of Railway Inspector
Name
Designation

Signature of Lab In charge
Name

Signature by AEN/XEN/CSP
Name
Designation

FORMAT - IX

**PROFORMA FOR CALIBRATION OF MACHINES / EQUIPMENTS AT CONCRETE
SLEEPER PLANT [IS: 516]**

Calibration – I**Calibration of Weigh batcher by Standard Dead Weight**

Date

Time

Next due on

S. No.	Dead load (Kg)	Observed load			Average observed load	Error	% Variation	Remarks
		1	2	3				
1	50							
2	100							
3	150							
4	200							
5	250							
6	300							
7	350							
8	400							
9	450							
10	500							

Signature of Railway Inspector
Name
Designation

Signature of Quality control In charge
Name

Signature of AEN/XEN/CSP
Name
Designation

FORMAT - X**Calibration – II****Calibration of Water meter**

Date Time Next Due on

S. No.	Actual water content (in liters)	Observed water content (in liters)			Average Observed water content (in liters)	Error	% Variation	Remarks
		1	2	3				
1								
2								
3								
4								
5								
6								
7								
8								
9								
10								

Signature of Railway Inspector
Name
Designation

Signature of Quality control In charge
Name

Signature of AEN/XEN/CSP
Name
Designation

FORMAT - XI**Calibration – III to VIII**

**Calibration of Static Bend Testing Machine, Concrete Cube Testing Machine,
Tensioning Jacks and Cement Mortar Cube Testing Machine**

PROVING RING NO

Date of Calibration

Valid up to

Calibration of M/c

Date & Time

Next Due

Name of machine / equipment :									
S. No.	Proving Ring Deflection Reading	Actual load	Observed load			Average observed load	Error	% Variation	Remarks
			1	2	3				
1									
2									
3									
4									
5									
6									
7									
8									
9									
10									

Signature of Railway Inspector
Name
Designation

Signature of Quality control In charge
Name

Signature of AEN/XEN/CSP
Name
Designation

TENSION REGISTER**Format –XII (A)**

[IS: 6006 - 2014]
For Stress Bench method

Batch No. :

Shift:

Date of Cast:

No. of Cast:

S. No.	Bench No.	Length of Wire (Bench) mm	Total cross section area of HTS wire mm ²	Young's Modulus of the Lot KN/mm ²	Initial Reading (KN)	Elongation in mm								Measured Elongation (B-A) (mm)	Pre-stressing force based on measured elongation from 50KN *P=E{(B-A)*a}/L	Total prestress force=(P+50)KN (Not less than 486KN)	Remarks
						Reading at 2x25 KN (A) (mm)				Final reading at 2 x 243 KN (B) (mm)							
						Left Side		Right Side		Left Side		Right Side					
						U	L	U	L	U	L	U	L				

$$*P=E\{(B-A)*a\}/L,$$

where P(KN), = pre stressing force (from 50KN to final pre stressing value),
 (B-A)(mm),=measured elongation
 a(mm²), = total cross sectional area of HTW wires
 L (mm) = effective wire length (from wedge to wedge clear length),
 E(KN/mm²)= Young's modulus (lot wise/IC wise)

- Note:** 1. Breakage or slippage of HTS wire, if any shall be recorded.
 2. Values of 'A' & 'B' shall be based on the respective sleeper drawings

Signature of Railway Inspector
Name
Designation

Signature of Shift Production In charge
Name

Counter signed by AEN/XEN/CSP
Name
Designation

TENSION REGISTER

[IS: 6006 - 2014]
For Long Line Method

Format –XII (B)

No. of Cast: Batch No. :		Batch:			Shift:			Date of Cast:			
Line no.	HTS wire no.	Length of Wire (Bed) mm	Cross sectional area of HTS wire mm ²	Young's Modulus of the Lot KN/mm ²	Initial Reading (KN)	Elongation in mm		Measured Elongation (mm) (B-A)	Pre-stressing force based on measured elongation $*P=E\{(B-A)*a\}/L$	Total prestress force= (P+3)KN (Not less than 27KN)	Remarks
						Reading at 3 KN (A) (mm)	Final reading at 27 KN (B) (cm)				

$*P=E\{(B-A)*a\}/L$, where, P= pre stressing force(KN), (B-A)=measured elongation (mm),
a= total cross sectional area of HTW wires(mm²),
L= effective wire length for entire length of bed(from wedge to wedge clear length)(Meter.)
E= Young's modulus (lot wise/IC wise)

- Note:**
- 1. Breakage or slippage of HTS wire, if any shall be recorded.**
 - 2. Values of 'A' & 'B' shall be based on the respective sleeper drawings**

Signature of Railway Inspector
Name
Designation

Signature of Shift Production In charge
Name

Counter signed by AEN/XEN/CSP
Name
Designation

10.30												
11.00												
11.30												
12.00												
12.30												
13.00												
13.30												
14.00												
14.30												
15.00												
15.30												
16.00												
16.30												

Signature of Railway Inspector
Name
Designation

Signature of Shift Production In charge
Name

Counter signed by AEN/XEN/CSP
Name
Designation

Format-XIV**PRODUCTION REGISTER**

On Date	
Monthly Production	
Cumulative	

Batch No. :**Date of Casting :****Shift :**

Steam Chamber No.	{1}	{2}	{3}	{4}	{5}	{6}	{7}	{8}	{9}	{10}
Bench No.										
Time of L.B.C										

RELEASE CUBE STRENGTH (STEAM CURED) to be tested by Lab in charge and Railway Supervisor.

Cube No.	Date of Testing	Time (in Hrs.)	Age (in Hrs.)	Weight (in Kgs)	Load (in KN)	N/mm ²	Remarks

WATER CUBE STRENGTH (WATER CURING)

Cube No.	Date of Testing	Time (in Hrs.)	Age (in days)	Weight (in Kgs)	Load (in KN)	N/mm ²	Remarks

FLEXURAL STRENGTH

Beam No.	Date of Testing	Age (in days)	Load (in KN)	Strength (in N/mm ²)	Remarks

STATIC BENDING TEST

Sleeper No.	Date of Testing	CENTRE		MR		MF		Remarks	Initial
		Top	Bottom	I	II	I	II		
		(KN)	(KN)	(KN)	(KN)	(KN)	(KN)		

Cement Source IC NO week no

HTS Source IC NO Heat No/s

SGCI Insert Source IC NO Heat No

HDPE Dowel Source IC NO Batch no

REJECTION DETAILS OF SLEEPERS

I.C. No. :

DATE OF ISSUE :

Total Rejected

No of sleepers passed as usable

Signature of Railway Inspector
Name
Designation

Signature of Shift Production In charge
Name

Signature of AEN/XEN/CSP
Name
Designation

Signature of Quality Control In charge
Designation

Format -XV**DIMENSION REGISTER**

Date of Casting : _____

No. of Cast : _____

Batch No. : _____

Offered for inspection : _____

Nos. of useable sleepers : _____

Date for inspection : _____

Sleep er No.	Outer Gauge	Rail Seat		Toe Gap				Surf ace defe cts	Height Gauge			Slope		Wind Gauge		F T C	Re mar ks
		Firm side	RT side	Firm side		RT side			E n d	Rail Seat	Cen tre	Firm side	RT side	Firm side	RT side		
				Outer	Inner	Outer	Inner										
1A																	
1B																	
1C																	
1D																	
2A																	
2B																	
2C																	
2D																	
3A																	
3B																	
3C																	

Nos. of Rejected = _____, Nos. of Usable = _____, Nos. of MF tested = _____

Note: 1. It should be ensured that the rejected (Red Marked) and MF tested (Yellow Marked) sleepers should not be dispatched.

2. AEN/XEN to do Dimension check as and when possible.

Signature of Railway Inspector
Name
Designation

Signature of Shift Production In charge
Name

Signature of AEN/XEN/CSP
Name
Designation

Signature of Quality Control In charge
Designation

SGCI Insert : DIMENSIONAL & WEIGHT CHECK LIST

Description: SGCI insert to RDSO/T-381 Alt.9 (or latest alteration) & specification IRS/T-46 (latest version)

SGCI Supplier: _____

Gauge Employed: Gauge and fixtures conforming to RDSO/T-454 Alt.9

IC no. and date (As issued by Purchaser/Inspecting authority)

S. No.	Heat No.	Pattern No.	Jig			Length of head 75±1	Thickness of stem 20/25+2/-1	Hole dia 22+1/-0	Width of head 67+1/-0.5	Top radius	Gating position	Square gauge	Wt in Kg. 1.55-3%	Soundness through hammer test
			G	G1	G2									

No. of inserts Checked _____, No. of inserts passed _____,

No. of inserts rejected _____, Rejection Rate :

Note:

1. Railway Inspector will check 1% inserts on random basis.
2. AEN/XEN will check at least 20 inserts, once in 2 weeks on random basis. He will also ensure that tests prescribed for Rly Inspectors are being conducted.
3. Other Instructions contained in Board's letter no. 98/TK-II/22/11/17/Pt. Policy, dtd. 11.08.2003 are to be adhered to.

Signature of Railway Inspector
Name
Designation

Signature of Quality Control In charge
Designation

Signature of AEN/XEN/CSP
Name
Designation

Format –XVI A**SGCI Insert : DIMENSIONAL & WEIGHT CHECK LIST**

Description: SGCI insert to RDSO/T-6901 Alt.5 (or latest alteration) & specification IRS/T-46 (1996) (latest version)

SGCI Supplier: _____

Gauge Employed: Gauge and fixtures conforming to RDSO/T-6943 Alt.3 IC no. and date (As issued by purchaser/Inspecting authority)

S. No.	Heat No.	Pattern No.	Jig			Length of head 76 +1/-0.5	Thickness of stem 25/35 +2/-1	Hole dia 23+0.5/-0	Width of head 71+1/-0.5	Top radius	Gating position	Square gauge	Wt in Kg. 1.484-3%	Soundness through hammer test
			G	G1	G2									

No. of inserts Checked _____, No. of inserts passed _____,

No. of inserts rejected _____, Rejection Rate:

Note:

1. Railway Inspector will check 1% inserts on random basis.
2. AEN/XEN will check at least 20 inserts, once in 2 weeks on random basis. He will also ensure that tests prescribed for Rly Inspectors are being conducted.
3. Other Instructions contained in Board's letter no. 98/TK-II/22/11/17/Pt. Policy, dtd. 11.08.2003 are to be adhered to.

Signature of Railway Inspector
Name
Designation

Signature of Quality Control In charge
Designation

Signature of AEN/XEN/CSP
Name
Designation

Format -XVII**STATISTICAL ANALYSIS OF CONCRETE STRENGTH AND STATIC BENDING STRENGTH TEST ON PSC SLEEPERS**

SLEEPERS FOR THE PERIOD: FROM _____ TO _____

i) NAME OF THE FIRM _____ LOCATION OF PLANT _____
RAILWAY _____

ii) TYPE OF SLEEPERS (MBC, TURNOUT & OTHER) TO DRG. NO RDSO/T – 2496 OR Drg. No. _____

- ii. Mix design approved by RDSO Vide letter-----
- iii. Compliance of last Over site inspection pending if any-----
- iv. Last inspection of Railway official on-----

A. CUBE STRENGTH :

Batch No. From _____	No. of Cube s	Rang e N/m m ²		Me an Val ue N/mm ²	Standard Deviation SD (N/mm ²)	Characterist ic value (N/mm ²)	Coefficien t of variation CV (%)	No. of observations below the minimum specified values i.e. 55/ 60 (N/mm ²)	No. of batches		Remarks
		M a x	Min						Double Testing	More than double testing	
Steam cube (Release strength)											
Water cube (15 days strength)											

B. FLEXURAL STRENGTH OF CONCRETE BEAM:

S. No.	Batch No.	Load (P) (KN)	Flexural strength (N/ mm ²)

Format – XVII Contd..**C. STATIC BENDING STRENGTH TEST RESULTS UPTO CRACKING LOAD OF MBC, TURNOUT, OTHER SLEEPER. :**

Description	Batch No.	No. of sleepers tested	Range (KN)	Mean value (KN)	Standard Deviation (KN)	Characteristic Strength (KN)	Coefficient of variation %	No. of observations below the min. specified values	No. of sleepers & No. of batches		Up to date No. of sleepers	
			Min	Max					Sleeper	Batch	Sleeper	Batch
Center top												
Rail Seat Bottom												

D. CONCRETE MIX DESIGN USED DURING THE PERIOD: FROM _____ To _____

(A) A/C Ratio _____ (B) W/C ratio _____ (C) Mix Proportion CA-I: _____% CA-II _____%, FA _____%

E. SOURCE OF CEMENT USED DURING THE PERIOD:**F. MEASURES TAKEN TO IMPROVE UPON THE DEFICIENCIES OBSERVED IN ABOVE TEST:**

-
- Note: 1. Separate analysis shall be submitted for MBC, Turnout and other sleepers.
2. The analysis should be for one calendar month.
3. Indicate change of source of raw materials, water etc, if any furnish a photocopy of their test report (s)

Signature of Railway Inspector
Name
Designation

Signature of Quality Control In charge
Designation

Signature of AEN/XEN/CSP
Name
Designation

Counter Signature of Dy.CE/CSP/HQ
Name

Format -XVIII

YEARLY STATISTICAL ANALYSIS
OF
CONCRETE STRENGTH AND STATIC BENDING STRENGTH TEST OF PSC
SLEEPERS

SLEEPERS FOR THE PERIOD: FROM _____ TO _____

- a) Name of The Firm : _____
 b) Location of Plant : _____
 c) Railway : _____
 d) Type of Sleepers (MBC, Turnout & Other) To Drg. No RDSO/T -2496 or Drg. No. _____

Month	Concrete Strength Water cured					SBT(Rail Seat)				MF			
	Nos. of cubes	Max	Min	CS	CV	Max	Min	CS	CV	Max	Min	CS	CV
April													
May													
June													
July													
Aug													
Sep													
Oct													
Nov													
Dec													
Jan													
Feb													
Mar													

Signature of Railway Inspector
Name
Designation

Signature of Quality Control In charge
Designation

Signature of AEN/XEN/CSP
Name
Designation

Counter Signature of Dy.CE/CSP/HQ
Name

Format -XIX**HTS Inspection Summary****Source:****BIS approval validity:****IC No.****Date of supply:**

Sl. No.	Description	
1	Lay length	
2	Weight/meter	
3	Breaking load	
4	% elongation	
5	0.2% proof stress	
6	Sulphur & phosphorus content	
7	Coil dia	
8	Packing condition	
9	Sealing of coils	
10.	Any sign of rusting of HTS wires	

Note

1. Item 1-5 are to be recorded from the Tests conducted at HTS factory and recorded in Original IC.
2. Item 6 is to be recorded from the Manufacturer's test certificate.
3. Item 7-10 are to be tested at CSP.

Signature of Railway Inspector
Name
Designation

Signature of Quality Control In charge
Designation

Signature of AEN/XEN/CSP
Name
Designation

Details of Mix Design

Mix Design parameters :			
1	Mix Design →	M-55	M-60
	RDSO Authority of approval		
	Date of approval		
	Cement	Kg	Kg
	Coarse aggregates, CA ₁	Kg	Kg
	Coarse aggregates, CA ₂	Kg	Kg
	Fine aggregates	Kg	Kg
	Admixture	kg	kg
	Water	Liters	Liters
	A/C Ratio		
	W/C Ratio		
	Sand : CA ₁ : CA ₂ ratio		

11.0 Granulometric limits for combined aggregates:

To be prepared for each Design mix separately as below:

<u>Sieve Size</u>	<u>%Limits (lower – higher)</u>	<u>Limits % passing.</u>
20 mm -
10 mm -
4.75 mm -
2.36 mm -
1.18 mm -
0.60 mm -
0.30 mm -
0.15 mm -

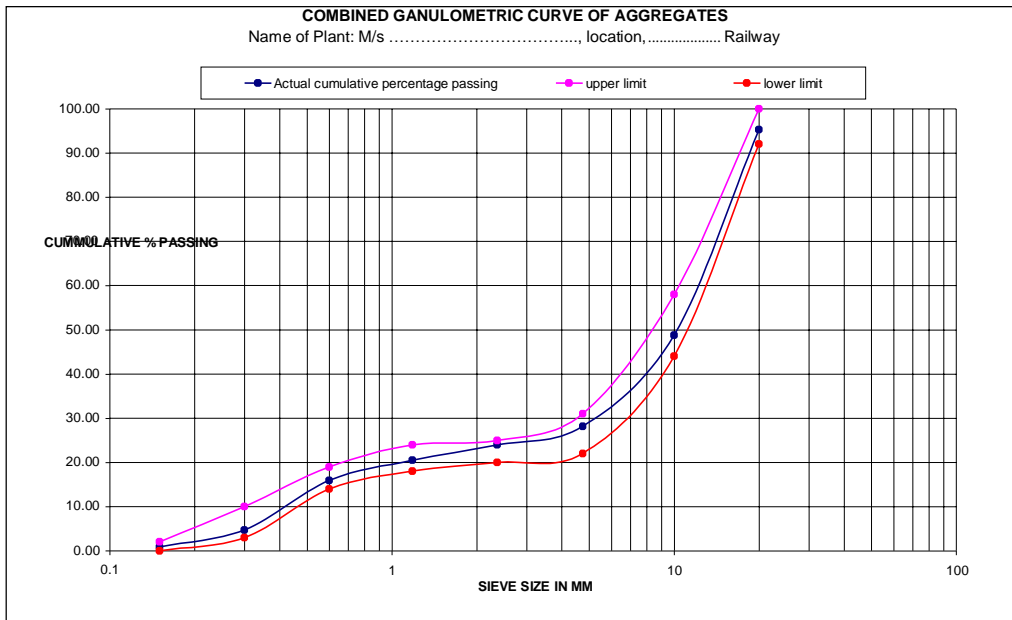

12.0 Steam Curing Cycle: The steam curing cycle for winter season and summer seasons, if varies may be given separately.

The following cycle is approved as follows:

- 1. Pre steaming = hrs. [> IST of cement]
 - 2. Rise in temperature = hrs.
 - 3. Constant Temp. = hrs.
 - 4. Cooling time = hrs.
-
- Total = hrs.

13.0 Submerged water curing: days.
 14 / 21 days compressive strength on the basis of 40 nos. of submerged water cubes & 40 nos. of steam cured cube analysis is found N/mm² and N/mm² respectively.

14.0 Statistical Analysis of Steam cured and water cured cubes: following details shall be submitted -

S. No.	R	M	SD	CS	CV	Remarks
1	Steam cured cubes					
2	Submerged water cured cubes					

Statistical analysis is done to assess the variation in test results. This analysis contains standard deviation, range of maximum & minimum, coefficient of variation (CV). By knowing the standard deviation, one can obtain characteristic value of corresponding item. Statistical analysis brings out overall health of the concrete sleeper plants. If the testing for working out statistical analysis is not done correctly the basic purpose of doing this whole exercise would be defeated.

Formulae are given below to calculate the mean value, standard deviation & coefficient of variation.

SAMPLE CALCULATION OF STATISTICAL ANALYSIS

S. No.	Compressive Strength (x) in N/mm ²	Frequency		F*x	ABS(X- X _{mean})	f * ABS(x-X _{mean}) ²	Remarks
		(f)					
1	52.00	1	I	52.00	5.82	33.87	1) Nos. of observations, N = 40 nos. 2) Mean, $X_{\text{mean}} = f*x / N$ $= 2312.91 / 40$ $= 57.82 \text{ N/mm}^2$ 3) Standard Deviation $SD = \text{SQRT}\{f * \text{ABS}(x-X_{\text{mean}})^2 / N\}$ $= 1.9598$ 4) Characteristic Strength, CS $F_{\text{ck}} = (X_{\text{mean}} - 1.96 * SD)$ 5) Coefficient of Variation, $C_v = (SD \times 100) / X_{\text{mean}}$ 6) Range = 8.44 N/mm ² (from 52.00 to 60.44)
2	53.33	2	II	106.66	4.49	40.32	
3	55.56	2	II	111.12	2.26	10.22	
4	56.00	3	III	168.00	1.82	9.94	
5	56.89	2	II	113.78	0.93	1.73	
6	57.33	5	IIII	286.65	0.49	1.20	
7	57.78	6	IIIIII	346.68	0.04	0.00	
8	58.22	2	II	116.44	0.40	0.32	
9	58.67	6	IIIIII	352.02	0.85	4.34	
10	59.56	4	IIII	238.24	1.74	12.11	
11	60.00	4	IIII	140.00	2.18	19.00	
12	60.44	3	III	181.32	2.62	20.59	
13							
14							
15							
16							
17							
18							
19							
20							
21							

22							
23							
24							
25							
..							
..							
	Total	40		2312.91		153.64	

**Signature of Railway
InspectorName
Designation**

**Signature of Quality Control In charge
Designation**

**Signature of AEN/XEN/CSP
Name
Designation**

Summary

Specific Procurement Notice (SPN)

PART 1 – TENDERING PROCEDURES

- Section I - Instructions to Tenderers (ITT)
- Section II - Tender Data Sheet (TDS)
- Section III - Evaluation and Qualification Criteria
- Section IV - Tender Forms
- Section V - Eligible Countries
- Section VI - Prohibited Practices

PART 2 – SUPPLY REQUIREMENTS

- Section VII – Schedule of Requirements

PART 3 – CONDITIONS OF CONTRACT AND CONTRACT FORMS

- Section VIII - General Conditions of Contract (GCC)
- Section IX - Particular Conditions of Contract (PCC)
- Section X - Contract Forms

PART 3 - Conditions of Contract and Contract Forms

Section VIII - General Conditions of Contract (GCC)**Clauses**

1. Definitions	5
2. Contract Documents	6
3. Prohibited Practices.....	6
4. Interpretation	6
5. Language.....	7
6. Joint Venture, Consortium or Association.....	8
7. Eligibility	8
8. Notices.....	8
9. Governing Law	8
10. Settlement of Disputes	9
11. Inspections and Audit by the Bank.....	9
12. Scope of Supply	9
13. Delivery and Documents.....	9
14. Supplier’s Responsibilities.....	10
15. Contract Price.....	10
16. Terms of Payment	10
17. Taxes and Duties.....	10
18. Performance Security	11
19. Copyright.....	11
20. Confidential Information	11
21. Subcontracting.....	12
22. Specifications and Standards	12
23. Packing and Documents.....	13

24. Insurance	13
25. Transportation and Incidental Services	13
26. Inspections and Tests	14
27. Liquidated Damages	15
28. Warranty	15
29. Patent Indemnity	16
30. Limitation of Liability	17
31. Change in Laws and Regulations	17
32. Force Majeure	18
33. Change Orders and Contract Amendments	18
34. Extensions of Time	20
35. Termination	20
36. Assignment	21
37. Export Restriction	21

Appendix to General Conditions: Prohibited Practices

Section VIII - General Conditions of Contract (GCC)**1. Definitions**

1.1 The following words and expressions shall have the meanings hereby assigned to them:

- (a) “Bank” means the Asian Infrastructure Investment Bank.
- (b) “Contract” means the Contract Agreement entered into between the Purchaser and the Supplier, together with the Contract Documents referred to therein, including all attachments, appendices and all documents incorporated by reference therein.
- (c) “Contract Documents” means the documents listed in the Contract Agreement, including any amendments thereto.
- (d) “Contract Price” means the price payable to the Supplier as specified in the Contract Agreement, subject to such additions and adjustments thereto or deductions therefrom, as may be made pursuant to the Contract.
- (e) “Day” means calendar day.
- (f) “Completion” means the fulfillment of the Related Services by the Supplier in accordance with the terms and conditions set forth in the Contract.
- (g) “GCC” means the General Conditions of Contract.
- (h) “Goods” means all of the commodities, raw material, machinery and equipment and/or other materials that the Supplier is required to supply to the Purchaser under the Contract.
- (i) “Purchaser’s Country” is the country specified in the Special Conditions of Contract (SCC).
- (j) “Purchaser” means the entity purchasing the Goods and Related Services, as named in the Contract Agreement and specified in the **SCC**.
- (k) “Related Services” means the services incidental to the supply of the goods, such as insurance, installation, training and initial maintenance and other such obligations of the Supplier under the Contract.
- (l) “SCC” means the Special Conditions of Contract.
- (m) “SubSupplier” means any person, private or government entity, or a combination of the above, to whom any part of

the Goods to be supplied or execution of any part of the Related Services is subcontracted by the Supplier.

- (n) “Supplier” means the person, private or government entity, or a combination of the above, whose Tender to perform the Contract has been accepted by the Purchaser and is named as such in the Contract Agreement.
- (o) “The Project Site,” where applicable, means the place named in the **SCC**.

2. **Contract Documents**

2.1 Subject to the order of precedence set forth in the Contract Agreement, all documents forming the Contract (and all parts thereof) are intended to be correlative, complementary and mutually explanatory. The Contract Agreement shall be read as a whole.

3. **Prohibited Practices**

- 3.1 The Bank requires compliance with the Bank’s Policy on Prohibited Practices as set forth in Appendix to the GCC.
- 3.2 The Purchaser requires the Supplier to disclose any commissions or fees that may have been paid or are to be paid to agents or any other party with respect to the tendering process or execution of the Contract. The information disclosed must include at least the name and address of the agent or other party; the amount and currency; and the purpose of the commission, gratuity or fee.

4. **Interpretation**

- 4.1 If the context so requires it, singular means plural and vice versa.
- 4.2 Incoterms
 - (a) Unless inconsistent with any provision of the Contract, the meaning of any trade term and the rights and obligations of parties thereunder shall be as prescribed by Incoterms specified in the **SCC**.
 - (b) The terms EXW, CIP and other similar terms, when used, shall be governed by the rules prescribed in the current edition of Incoterms specified in the **SCC** and published by the International Chamber of Commerce in Paris, France.

4.3 Entire Agreement

The Contract constitutes the entire agreement between the Purchaser and the Supplier and supersedes all communications, negotiations and agreements (whether written or oral) of the parties with respect thereto made prior to the date of Contract.

4.4 Amendment

No amendment or other variation of the Contract shall be valid unless it is in writing, is dated, expressly refers to the Contract, and is signed by a duly authorized representative of each party thereto.

4.5 Nonwaiver

- (a) Subject to GCC Sub-Clause 4.5(b) below, no relaxation, forbearance, delay or indulgence by either party in enforcing any of the terms and conditions of the Contract or the granting of time by either party to the other shall prejudice, affect or restrict the rights of that party under the Contract, neither shall any waiver by either party of any breach of Contract operate as waiver of any subsequent or continuing breach of Contract.
- (b) Any waiver of a party's rights, powers or remedies under the Contract must be in writing, dated and signed by an authorized representative of the party granting such waiver, and must specify the right and the extent to which it is being waived.

4.6 Severability

If any provision or condition of the Contract is prohibited or rendered invalid or unenforceable, such prohibition, invalidity or unenforceability shall not affect the validity or enforceability of any other provisions and conditions of the Contract.

5. Language

- 5.1 The Contract as well as all correspondence and documents relating to the Contract exchanged by the Supplier and the Purchaser, shall be written in the language specified in the **SCC**. Supporting documents and printed literature that are part of the Contract may be in another language provided they are accompanied by an accurate translation of the relevant passages in the language specified, in which case, for purposes of interpretation of the Contract, this translation shall govern.
- 5.2 The Supplier shall bear all costs of translation to the governing language and all risks of the accuracy of such translation, for documents provided by the Supplier.

- 6. Joint Venture, Consortium or Association**
- 6.1 If the Supplier is a joint venture, consortium or association, all of the parties shall be jointly and severally liable to the Purchaser for the fulfillment of the provisions of the Contract and shall designate one party to act as a leader with authority to bind the joint venture, consortium or association. The composition or the constitution of the joint venture, consortium or association shall not be altered without the prior consent of the Purchaser.
- 7. Eligibility**
- 7.1 The Supplier and its SubSuppliers shall have the nationality of an eligible country. A Supplier or SubSupplier shall be deemed to have the nationality of a country if it is a citizen or constituted, incorporated or registered, and operates in conformity with the provisions of the laws of that country.
- 7.2 All Goods and Related Services to be supplied under the Contract and financed by the Bank shall have their origin in Eligible Countries. For the purpose of this Clause origin means the country where the goods have been grown, mined, cultivated, produced, manufactured or processed; or through manufacture, processing or assembly, another commercially recognized article result that differs substantially in its basic characteristics from its components.
- 8. Notices**
- 8.1 Any notice given by one party to the other pursuant to the Contract shall be in writing to the address specified in the **SCC**. The term “in writing” means communicated in written form with proof of receipt.
- 8.2 A notice shall be effective when delivered or on the notice’s effective date, whichever is later.
- 9. Governing Law**
- 9.1 The Contract shall be governed by and interpreted in accordance with the laws of the Purchaser’s Country, unless otherwise specified in the **SCC**.
- 9.2 Throughout the execution of the Contract, the Supplier shall comply with the import of goods and services prohibitions in the Purchaser’s Country when
- (a) as a matter of law or official regulations, the Recipient’s country prohibits commercial relations with that country; or
 - (b) by an act of compliance with a decision of the United Nations Security Council taken under Chapter VII of the Charter of the United Nations, the Recipient’s Country prohibits any import of goods from that country or any payments to any country, person or entity in that country.

- 10. Settlement of Disputes**
- 10.1 The Purchaser and the Supplier shall make every effort to resolve amicably by direct informal negotiation any disagreement or dispute arising between them under or in connection with the Contract.
- 10.2 If, after twenty-eight (28) days, the parties have failed to resolve their dispute or difference by such mutual consultation, then either the Purchaser or the Supplier may give notice to the other party of its intention to commence arbitration, as hereinafter provided, as to the matter in dispute, and no arbitration in respect of this matter may be commenced unless such notice is given. Any dispute or difference in respect of which a notice of intention to commence arbitration has been given in accordance with this Clause shall be finally settled by arbitration. Arbitration may be commenced prior to or after delivery of the Goods under the Contract. Arbitration proceedings shall be conducted in accordance with the rules of procedure specified in the **SCC**.
- 10.3 Notwithstanding any reference to arbitration herein,
- (a) the parties shall continue to perform their respective obligations under the Contract unless they otherwise agree; and
- (b) the Purchaser shall pay the Supplier any monies due the Supplier.
- 11. Inspections and Audit by the Bank**
- 11.1 The Supplier shall keep, and shall make all reasonable efforts to cause its SubSuppliers to keep, accurate and systematic accounts and records in respect of the Goods in such form and details as will clearly identify relevant time changes and costs.
- 11.2 The Supplier shall permit and shall cause its agents (whether declared or not), subSuppliers, subconsultants, service providers, suppliers and their personnel, to permit the Bank and/or persons appointed by the Bank to inspect the site and/or the accounts, records and other documents relating to the procurement process, tender submission, proposal submission, and contract execution, and to have such accounts, records and other documents audited by auditors appointed by the Bank.
- 12. Scope of Supply**
- 12.1 The Goods and Related Services to be supplied shall be as specified in the Schedule of Requirements.
- 13. Delivery and Documents**
- 13.1 Subject to GCC Sub-Clause 33.1, the Delivery of the Goods and Completion of the Related Services shall be in accordance with the Delivery and Completion Schedule specified in the Schedule of Requirements. The details of shipping and other documents to be furnished by the Supplier are specified in the **SCC**.

- 14. Supplier's Responsibilities** 14.1 The Supplier shall supply all the Goods and Related Services included in the Scope of Supply in accordance with GCC Clause 12, and the Delivery and Completion Schedule, as per GCC Clause 13.
- 15. Contract Price** 15.1 Prices charged by the Supplier for the Goods supplied and the Related Services performed under the Contract shall not vary from the prices quoted by the Supplier in its Tender, with the exception of any price adjustments authorized in the **SCC**.
- 16. Terms of Payment**
- 16.1 The Contract Price, including any Advance Payments, if applicable, shall be paid as specified in the **SCC**.
- 16.2 The Supplier's request for payment shall be made to the Purchaser in writing, accompanied by invoices describing, as appropriate, the Goods delivered and Related Services performed, and by the documents submitted pursuant to GCC Clause 13 and upon fulfillment of all other obligations stipulated in the Contract.
- 16.3 Payments shall be made promptly by the Purchaser, but in no case later than sixty (60) days after submission of an invoice or request for payment by the Supplier, and after the Purchaser has accepted it.
- 16.4 The currencies in which payments shall be made to the Supplier under this Contract shall be those in which the Tender price is expressed.
- 16.5 In the event that the Purchaser fails to pay the Supplier any payment by its due date or within the period set forth in the **SCC**, the Purchaser shall pay to the Supplier interest on the amount of such delayed payment at the rate shown in the **SCC**, for the period of delay until payment has been made in full, whether before or after judgment or arbitration award.
- 17. Taxes and Duties**
- 17.1 For goods manufactured outside the Purchaser's Country, the Supplier shall be entirely responsible for all taxes, stamp duties, license fees and other such levies imposed outside the Purchaser's Country.
- 17.2 For goods manufactured within the Purchaser's Country, the Supplier shall be entirely responsible for all taxes, duties, license fees, etc., incurred until delivery of the contracted Goods to the Purchaser.
- 17.3 If any tax exemptions, reductions, allowances or privileges may be available to the Supplier in the Purchaser's Country, the Purchaser shall use its best efforts to enable the Supplier to benefit from any such tax savings to the maximum allowable extent.

- 18. Performance Security**
- 18.1 If required as specified in the SCC, the Supplier shall, within twenty-eight (28) days of the notification of contract award, provide a performance security for the performance of the Contract in the amount specified in the **SCC**.
- 18.2 The proceeds of the Performance Security shall be payable to the Purchaser as compensation for any loss resulting from the Supplier's failure to complete its obligations under the Contract.
- 18.3 As specified in the **SCC**, the Performance Security, if required, shall be denominated in the currency(ies) of the Contract, or in a freely convertible currency acceptable to the Purchaser; and shall be in the format stipulated by the Purchaser in the **SCC**, or in another format acceptable to the Purchaser.
- 18.4 The Performance Security shall be discharged by the Purchaser and returned to the Supplier not later than twenty-eight (28) days following the date of Completion of the Supplier's performance obligations under the Contract, including any warranty obligations, unless specified otherwise in the **SCC**.
- 19. Copyright**
- 19.1 The copyright in all drawings, documents and other materials containing data and information furnished to the Purchaser by the Supplier herein shall remain vested in the Supplier, or, if they are furnished to the Purchaser directly or through the Supplier by any third party, including suppliers of materials, the copyright in such materials shall remain vested in such third party
- 20. Confidential Information**
- 20.1 The Purchaser and the Supplier shall keep confidential and shall not, without the written consent of the other party hereto, divulge to any third party any documents, data or other information furnished directly or indirectly by the other party hereto in connection with the Contract, whether such information has been furnished prior to, during or following completion or termination of the Contract. Notwithstanding the above, the Supplier may furnish to its SubSupplier such documents, data and other information it receives from the Purchaser to the extent required for the SubSupplier to perform its work under the Contract, in which event the Supplier shall obtain from such SubSupplier an undertaking of confidentiality similar to that imposed on the Supplier under GCC Clause 20.
- 20.2 The Purchaser shall not use such documents, data and other information received from the Supplier for any purposes unrelated to the contract. Similarly, the Supplier shall not use such documents, data and other information received from the Purchaser for any purpose other than the performance of the Contract.

20.3 The obligation of a party under GCC Sub-Clauses 20.1 and 20.2 above, however, shall not apply to information that:

- (a) the Purchaser or Supplier need to share with the Bank or other institutions participating in the financing of the Contract;
- (b) now or hereafter enters the public domain through no fault of that party;
- (c) can be proven to have been possessed by that party at the time of disclosure and which was not previously obtained, directly or indirectly, from the other party or
- (d) otherwise lawfully becomes available to that party from a third party that has no obligation of confidentiality.

20.4 The above provisions of GCC Clause 20 shall not in any way modify any undertaking of confidentiality given by either of the parties hereto prior to the date of the Contract in respect of the Supply or any part thereof.

20.5 The provisions of GCC Clause 20 shall survive completion or termination, for whatever reason, of the Contract.

21. Subcontracting

21.1 The Supplier shall notify the Purchaser in writing of all subcontracts awarded under the Contract if not already specified in the Tender. Such notification, in the original Tender or later shall not relieve the Supplier from any of its obligations, duties, responsibilities or liability under the Contract.

21.2 Subcontracts shall comply with the provisions of GCC Clauses 3 and 7.

22. Specifications and Standards

22.1 Technical Specifications and Drawings

- (a) The Goods and Related Services supplied under this Contract shall conform to the technical specifications and standards as specified in the Schedule of Supply part of the Contract and, when no applicable standard is mentioned, the standard shall be equivalent or superior to the official standards whose application is appropriate to the Goods' country of origin.
- (b) The Supplier shall be entitled to disclaim responsibility for any design, data, drawing, specification or other document, or any modification thereof provided or designed by or on behalf of the Purchaser, by giving a notice of such disclaimer to the Purchaser.

- (c) Wherever references are made in the Contract to codes and standards in accordance with which it shall be executed, the edition or the revised version of such codes and standards shall be those specified in the Schedule of Supply part of the Contract. During Contract execution, any changes in any such codes and standards shall be applied only after approval by the Purchaser and shall be treated in accordance with GCC Clause 33.

23. Packing and Documents

- 23.1 The Supplier shall provide such packing of the Goods as is required to prevent their damage or deterioration during transit to their final destination, as indicated in the Contract. During transit, the packing shall be sufficient to withstand, without limitation, rough handling and exposure to extreme temperatures, salt and precipitation and open storage. Packing case size and weights shall take into consideration, where appropriate, the remoteness of the goods' final destination and the absence of heavy handling facilities at all points in transit.
- 23.2 The packing, marking and documentation within and outside the packages shall comply strictly with such special requirements as shall be expressly provided for in the Contract, including additional requirements, if any, specified in the **SCC**, and in any other instructions ordered by the Purchaser.

24. Insurance

- 24.1 Unless otherwise specified in the **SCC**, the Goods supplied under the Contract shall be fully insured—in a freely convertible currency from an eligible country—against loss or damage incidental to manufacture or acquisition, transportation, storage and delivery, in accordance with the applicable Incoterms or in the manner specified in the **SCC**.

25. Transportation and Incidental Services

- 25.1 Unless otherwise specified in the **SCC**, responsibility for arranging transportation of the Goods shall be in accordance with the specified Incoterms.
- 25.2 The Supplier may be required to provide any or all of the following services, including additional services, if any, specified in **SCC**:
- (a) performance or supervision of on-site assembly and/or start-up of the supplied Goods;
 - (b) furnishing of tools required for assembly and/or maintenance of the supplied Goods;
 - (c) furnishing of a detailed operations and maintenance manual for each appropriate unit of the supplied Goods;
 - (d) performance or supervision or maintenance and/or repair of the supplied Goods, for a period of time agreed by the

parties, provided that this service shall not relieve the Supplier of any warranty obligations under this Contract; and

- (e) training of the Purchaser's personnel, at the Supplier's plant and/or on-site, in assembly, start-up, operation, maintenance and/or repair of the supplied Goods.

25.3 Prices charged by the Supplier for incidental services, if not included in the Contract Price for the Goods, shall be agreed upon in advance by the parties and shall not exceed the prevailing rates charged to other parties by the Supplier for similar services.

26. Inspections and Tests

26.1 The Supplier shall at its own expense and at no cost to the Purchaser carry out all such tests and/or inspections of the Goods and Related Services as are specified in the **SCC**.

26.2 The inspections and tests may be conducted on the premises of the Supplier or its SubSupplier, at point of delivery, and/or at the Goods' final destination, or in another place in the Purchaser's Country as specified in the **SCC**. Subject to GCC Sub-Clause 26.3, if conducted on the premises of the Supplier or its SubSupplier, all reasonable facilities and assistance, including access to drawings and production data, shall be furnished to the inspectors at no charge to the Purchaser.

26.3 The Purchaser or its designated representative shall be entitled to attend the tests and/or inspections referred to in GCC Sub-Clause 26.2, provided that the Purchaser bear all of its own costs and expenses incurred in connection with such attendance including, but not limited to, all traveling and board and lodging expenses.

26.4 Whenever the Supplier is ready to carry out any such test and inspection, it shall give a reasonable advance notice, including the place and time, to the Purchaser. The Supplier shall obtain from any relevant third party or manufacturer any necessary permission or consent to enable the Purchaser or its designated representative to attend the test and/or inspection.

26.5 The Purchaser may require the Supplier to carry out any test and/or inspection not required by the Contract but deemed necessary to verify that the characteristics and performance of the Goods comply with the technical specifications, codes and standards under the Contract, provided that the Supplier's reasonable costs and expenses incurred in the carrying out of such test and/or inspection shall be added to the Contract Price. Further, if such test and/or inspection impedes the progress of manufacturing and/or the Supplier's performance of its other

obligations under the Contract, due allowance will be made in respect of the Delivery Dates and Completion Dates and the other obligations so affected.

26.6 The Supplier shall provide the Purchaser with a report of the results of any such test and/or inspection.

26.7 The Purchaser may reject any Goods or any part thereof that fail to pass any test and/or inspection or do not conform to the specifications. The Supplier shall either rectify or replace such rejected Goods or parts thereof or make alterations necessary to meet the specifications at no cost to the Purchaser, and shall repeat the test and/or inspection, at no cost to the Purchaser, upon giving a notice pursuant to GCC Sub-Clause 26.4.

26.8 The Supplier agrees that neither the execution of a test and/or inspection of the Goods or any part thereof, nor the attendance by the Purchaser or its representative, nor the issue of any report pursuant to GCC Sub-Clause 26.6, shall release the Supplier from any warranties or other obligations under the Contract.

27. Liquidated Damages

27.1 Except as provided under GCC Clause 32, if the Supplier fails to deliver any or all of the Goods by the Date(s) of delivery or perform the Related Services within the period specified in the Contract, the Purchaser may without prejudice to all its other remedies under the Contract, deduct from the Contract Price, as liquidated damages, a sum equivalent to the percentage specified in the **SCC** of the delivered price of the delayed Goods or unperformed Services for each week or part thereof of delay until actual delivery or performance, up to a maximum deduction of the percentage specified in those **SCC**. Once the maximum is reached, the Purchaser may terminate the Contract pursuant to GCC Clause 35.

28. Warranty

28.1 The Supplier warrants that all the Goods are new, unused, and of the most recent or current models, and that they incorporate all recent improvements in design and materials, unless provided otherwise in the Contract.

28.2 Subject to GCC 22.1(b), the Supplier further warrants that the Goods shall be free from defects arising from any act or omission of the Supplier or arising from design, materials and workmanship, under normal use in the conditions prevailing in the country of final destination.

28.3 Unless otherwise specified in the **SCC**, the warranty shall remain valid for twelve (12) months after the Goods, or any portion thereof as the case may be, have been delivered to and accepted at the final destination indicated in the **SCC**, or for eighteen (18) months after the date of shipment from the port or place of

loading in the country of origin, whichever period concludes earlier.

28.4 The Purchaser shall give notice to the Supplier stating the nature of any such defects together with all available evidence thereof, promptly following the discovery thereof. The Purchaser shall afford all reasonable opportunity for the Supplier to inspect such defects.

28.5 Upon receipt of such notice, the Supplier shall, within the period specified in the **SCC**, expeditiously repair or replace the defective Goods or parts thereof, at no cost to the Purchaser.

28.6 If having been notified, the Supplier fails to remedy the defect within the period specified in the **SCC**, the Purchaser may proceed to take within a reasonable period such remedial action as may be necessary, at the Supplier's risk and expense and without prejudice to any other rights which the Purchaser may have against the Supplier under the Contract.

29. Patent Indemnity

29.1 The Supplier shall, subject to the Purchaser's compliance with GCC Sub-Clause 29.2, indemnify and hold harmless the Purchaser and its employees and officers from and against any and all suits, actions or administrative proceedings, claims, demands, losses, damages, costs and expenses of any nature, including attorney's fees and expenses, which the Purchaser may suffer as a result of any infringement or alleged infringement of any patent, utility model, registered design, trademark, copyright or other intellectual property right registered or otherwise existing at the date of the Contract by reason of:

- (a) the installation of the Goods by the Supplier or the use of the Goods in the country where the Site is located; and
- (b) the sale in any country of the products produced by the Goods.

Such indemnity shall not cover any use of the Goods or any part thereof other than for the purpose indicated by or to be reasonably inferred from the Contract, neither any infringement resulting from the use of the Goods or any part thereof, or any products produced thereby in association or combination with any other equipment, plant or materials not supplied by the Supplier, pursuant to the Contract.

29.2 If any proceedings are brought or any claim is made against the Purchaser arising out of the matters referred to in GCC Sub-Clause 29.1, the Purchaser shall promptly give the Supplier a notice thereof, and the Supplier may at its own expense and in the Purchaser's name conduct such proceedings or claim and

any negotiations for the settlement of any such proceedings or claim.

29.3 If the Supplier fails to notify the Purchaser within twenty-eight (28) days after receipt of such notice that it intends to conduct any such proceedings or claim, then the Purchaser shall be free to conduct the same on its own behalf.

29.4 The Purchaser shall, at the Supplier's request, afford all available assistance to the Supplier in conducting such proceedings or claim, and shall be reimbursed by the Supplier for all reasonable expenses incurred in so doing.

29.5 The Purchaser shall indemnify and hold harmless the Supplier and its employees, officers and SubSuppliers from and against any and all suits, actions or administrative proceedings, claims, demands, losses, damages, costs and expenses of any nature, including attorney's fees and expenses, which the Supplier may suffer as a result of any infringement or alleged infringement of any patent, utility model, registered design, trademark, copyright or other intellectual property right registered or otherwise existing at the date of the Contract arising out of or in connection with any design, data, drawing, specification or other documents or materials provided or designed by or on behalf of the Purchaser.

30. Limitation of Liability

30.1 Except in cases of criminal negligence or willful misconduct,

- (a) the Supplier shall not be liable to the Purchaser, whether in contract, tort or otherwise, for any indirect or consequential loss or damage, loss of use, loss of production or loss of profits or interest costs, provided that this exclusion shall not apply to any obligation of the Supplier to pay liquidated damages to the Purchaser; and
- (b) the aggregate liability of the Supplier to the Purchaser, whether under the Contract, in tort or otherwise, shall not exceed the total Contract Price, provided that this limitation shall not apply to the cost of repairing or replacing defective equipment, or to any obligation of the supplier to indemnify the Purchaser with respect to patent infringement.

31. Change in Laws and Regulations

31.1 Unless otherwise specified in the Contract, if after the date of 28 days prior to date of Tender submission, any law, regulation, ordinance, order or bylaw having the force of law is enacted, promulgated, abrogated, or changed in the place of the Purchaser's Country where the Site is located (which shall be deemed to include any change in interpretation or application by the competent authorities) that subsequently affects the Delivery Date and/or the Contract Price, then such Delivery Date and/or Contract Price shall be correspondingly increased or decreased,

to the extent that the Supplier has thereby been affected in the performance of any of its obligations under the Contract. Notwithstanding the foregoing, such additional or reduced cost shall not be separately paid or credited if the same has already been accounted for in the price adjustment provisions where applicable, in accordance with GCC Clause 15.

- 32. Force Majeure**
- 32.1 The Supplier shall not be liable for forfeiture of its Performance Security, liquidated damages or termination for default if and to the extent that its delay in performance or other failure to perform its obligations under the Contract is the result of an event of Force Majeure.
- 32.2 For purposes of this Clause, “Force Majeure” means an event or situation beyond the control of the Supplier that is not foreseeable, is unavoidable, and its origin is not due to negligence or lack of care on the part of the Supplier. Such events may include, but not be limited to, acts of the Purchaser in its sovereign capacity, wars or revolutions, fires, floods, epidemics, quarantine restrictions and freight embargoes.
- 32.3 If a Force Majeure situation arises, the Supplier shall promptly notify the Purchaser in writing of such condition and the cause thereof. Unless otherwise directed by the Purchaser in writing, the Supplier shall continue to perform its obligations under the Contract as far as is reasonably practical, and shall seek all reasonable alternative means for performance not prevented by the Force Majeure event.
- 33. Change Orders and Contract Amendments**
- 33.1 The Purchaser may at any time order the Supplier through notice in accordance GCC Clause 8, to make changes within the general scope of the Contract in any one or more of the following:
- (a) drawings, designs or specifications, where Goods to be furnished under the Contract are to be specifically manufactured for the Purchaser;
 - (b) the method of shipment or packing;
 - (c) the place of delivery and
 - (d) the Related Services to be provided by the Supplier.
- 33.2 If any such change causes an increase or decrease in the cost of, or the time required for, the Supplier’s performance of any provisions under the Contract, an equitable adjustment shall be made in the Contract Price or in the Delivery/Completion Schedule, or both, and the Contract shall accordingly be amended. Any claims by the Supplier for adjustment under this

Clause must be asserted within twenty-eight (28) days from the date of the Supplier's receipt of the Purchaser's change order.

33.3 Prices to be charged by the Supplier for any Related Services that might be needed but which were not included in the Contract shall be agreed upon in advance by the parties and shall not exceed the prevailing rates charged to other parties by the Supplier for similar services.

33.4 **Value Engineering:** The Supplier may prepare, at its own cost, a value engineering proposal at any time during the performance of the contract. The value engineering proposal shall, at a minimum, include the following;

- (a) the proposed change(s), and a description of the difference to the existing contract requirements;
- (b) a full cost/benefit analysis of the proposed change(s), including a description and estimate of costs (including life cycle costs) the Purchaser may incur in implementing the value engineering proposal and
- (c) a description of any effect(s) of the change on performance/functionality.

The Purchaser may accept the value engineering proposal if the proposal demonstrates benefits that:

- (a) accelerates the delivery period; or
- (b) reduces the Contract Price or the life cycle costs to the Purchaser; or
- (c) improves the quality, efficiency or sustainability of the Goods; or
- (d) yields any other benefits to the Purchaser,

without compromising the necessary functions of the Goods.

If the value engineering proposal is approved by the Purchaser and results in:

- (a) a reduction of the Contract Price; the amount to be paid to the Supplier shall be the percentage specified in the **SCC** of the reduction in the Contract Price; or
- (b) an increase in the Contract Price, but results in a reduction in life cycle costs due to any benefit described in (a) to (d) above, the amount to be paid

to the Supplier shall be the full increase in the Contract Price.

33.5 Subject to the above, no variation in or modification of the terms of the Contract shall be made except by written amendment signed by the parties.

34. Extensions of Time

34.1 If at any time during performance of the Contract, the Supplier or its subSuppliers should encounter conditions impeding timely delivery of the Goods or completion of Related Services pursuant to GCC Clause 13, the Supplier shall promptly notify the Purchaser in writing of the delay, its likely duration, and its cause. As soon as practicable after receipt of the Supplier's notice, the Purchaser shall evaluate the situation and may at its discretion extend the Supplier's time for performance, in which case the extension shall be ratified by the parties by amendment of the Contract.

34.2 Except in case of Force Majeure, as provided under GCC Clause 32, a delay by the Supplier in the performance of its Delivery and Completion obligations shall render the Supplier liable to the imposition of liquidated damages pursuant to GCC Clause 26, unless an extension of time is agreed upon, pursuant to GCC Sub-Clause 34.1.

35. Termination

35.1 Termination for Default

- (a) The Purchaser, without prejudice to any other remedy for breach of Contract, by written notice of default sent to the Supplier, may terminate the Contract in whole or in part:
 - (i) if the Supplier fails to deliver any or all of the Goods within the period specified in the Contract, or within any extension thereof granted by the Purchaser pursuant to GCC Clause 34;
 - (ii) if the Supplier fails to perform any other obligation under the Contract or
 - (iii) if the Supplier, in the judgment of the Purchaser has engaged in Prohibited Practices, as defined in paragraph 2 of the Appendix to the GCC, in competing for or in executing the Contract.
- (b) In the event the Purchaser terminates the Contract in whole or in part, pursuant to GCC Clause 35.1(a), the Purchaser may procure, upon such terms and in such manner as it deems appropriate, Goods or Related Services similar to those undelivered or not performed, and the Supplier shall be liable to the Purchaser for any

additional costs for such similar Goods or Related Services. However, the Supplier shall continue performance of the Contract to the extent not terminated.

35.2 Termination for Insolvency

- (a) The Purchaser may at any time terminate the Contract by giving notice to the Supplier if the Supplier becomes bankrupt or otherwise insolvent. In such event, termination will be without compensation to the Supplier, provided that such termination will not prejudice or affect any right of action or remedy that has accrued or will accrue thereafter to the Purchaser.

35.3 Termination for Convenience.

- (a) The Purchaser, by notice sent to the Supplier, may terminate the Contract, in whole or in part, at any time for its convenience. The notice of termination shall specify that termination is for the Purchaser's convenience, the extent to which performance of the Supplier under the Contract is terminated, and the date upon which such termination becomes effective.
- (b) The Goods that are complete and ready for shipment within twenty-eight (28) days after the Supplier's receipt of notice of termination shall be accepted by the Purchaser at the Contract terms and prices. For the remaining Goods, the Purchaser may elect:
 - (i) to have any portion completed and delivered at the Contract terms and prices; and/or
 - (ii) to cancel the remainder and pay to the Supplier an agreed amount for partially completed Goods and Related Services and for materials and parts previously procured by the Supplier.

36. Assignment

36.1 Neither the Purchaser nor the Supplier shall assign, in whole or in part, their obligations under this Contract, except with prior written consent of the other party.

37. Export Restriction

37.1 Notwithstanding any obligation under the Contract to complete all export formalities, any export restrictions attributable to the Purchaser, to the country of the Purchaser, or to the use of the products/goods, systems or services to be supplied, which arise from trade regulations from a country supplying those products/goods, systems or services, and which substantially impede the Supplier from meeting its obligations under the Contract, shall release the Supplier from the obligation to provide

deliveries or services, always provided, however, that the Supplier can demonstrate to the satisfaction of the Purchaser and of the Bank that it has completed all formalities in a timely manner, including applying for permits, authorizations and licenses necessary for the export of the products/goods, systems or services under the terms of the Contract. Termination of the Contract on this basis shall be for the Purchaser's convenience pursuant to Sub-Clause 35.3.

APPENDIX TO GENERAL CONDITIONS

Prohibited Practices

1. The Bank requires that the Recipient (and all other beneficiaries of the Bank financing), as well as tenderers, suppliers, Suppliers, concessionaires and consultants under Bank-financed contracts for the Project, observe the highest standard of transparency and integrity during the procurement, execution and implementation of such contracts.
2. Definitions. In pursuance of this policy, the Bank defines the terms set forth below as Prohibited Practices:
 - (a) “**Coercive practice**” means impairing or harming or threatening to impair or harm, directly or indirectly, any party or the property of a party to influence improperly the actions of a party.
 - (b) “**Collusive practice**” means an arrangement between two or more parties designed to achieve an improper purpose, including to influence improperly the actions of another party.
 - (c) “**Corrupt practice**” means the offering, giving, receiving or soliciting, directly or indirectly, of anything of value to influence improperly the actions of another party.
 - (d) “**Fraudulent practice**” means any act or omission, including a misrepresentation, that knowingly or recklessly misleads or attempts to mislead, a party to obtain a financial or other benefit or to avoid an obligation.
 - (e) “**Misuse of resources**” means improper use of the Bank’s resources, carried out either intentionally or through reckless disregard.
 - (f) “**Obstructive practice**” means any of the following practices: (i) deliberately destroying, falsifying, altering or concealing of evidence material to a Bank investigation; (ii) making false statements to investigators in order to materially impede a Bank investigation into allegations of a Prohibited Practice; (iii) failing to comply with requests to provide information, documents or records in connection with a Bank investigation; (iv) threatening, harassing or intimidating any party to prevent it from disclosing its knowledge of matters relevant to a Bank investigation or from pursuing the investigation or (v) materially impeding the exercise of the Bank’s contractual rights of audit or inspection or access to information.
 - (g) “**Theft**” means the misappropriation of property belonging to another party.
3. Any occurrence, or suspected occurrence, of a Prohibited Practice in the procurement, award or implementation of a Bank-financed contract is dealt with in accordance with the provisions of the Bank’s Policy on Prohibited Practices. Suppliers, Suppliers, service providers and consultants selected pursuant to the provisions of Section II and concessionaires selected pursuant to paragraph 14.3 of the Bank’s Procurement Instructions for Recipients, as well as the Recipient shall fully cooperate with the Bank (or a co-financier undertaking an investigation pursuant to paragraph 6.1 of the Bank’s Procurement Instructions for Recipients) in any investigation into an alleged Prohibited Practice to be carried out pursuant to the Policy on Prohibited Practices, and permit the Bank or its representative (including such co-financier) to inspect such of their accounts

and records as may be relevant for such investigation and to have such records and accounts audited by the auditors appointed by the Bank.

4. Provisions to this effect are included in the Legal Agreements and the procurement contracts with such entities.
5. If the Project is financed by a sovereign-backed loan, the Bank (or, where relevant, a co-financier having undertaken an investigation pursuant to paragraph 6.1 of the Bank's Procurement Instructions for Recipients):
 - (a) may take any of the following additional actions in connection with a Prohibited Practice under the Project:
 - (i) reject a proposal for award if it determines that the tenderer recommended for award, or any of its personnel, or its agents, or its subconsultants, subSuppliers, service providers, suppliers or their employees, has, directly or indirectly, engaged in a prohibited practice in competing for the contract in question; and
 - (ii) cancel the undisbursed portion of the loan allocated to a contract (and require reimbursement of the disbursed portion of the loan allocated to the contract) if it determines at any time that representatives of the Recipient or of a recipient of any part of the proceeds of the loan engaged in a prohibited practice during the procurement, administration or implementation of the contract in question; and
 - (b) requires that a clause be included in tender documents and in contracts financed by the Bank loan, requiring tenderers, suppliers and Suppliers and their subSuppliers, agents, personnel, consultants, service providers or suppliers, to permit the Bank (and a co-financier undertaking an investigation pursuant to paragraph 6.1 of the Bank's Procurement Instructions for Recipients) to inspect all accounts, records and other documents relating to the submission of tenders and contract performance, and to have them audited by auditors appointed by the Bank.

Section IX - Special Conditions of Contract (SCC)

The following Special Conditions of Contract (SCC) shall supplement and / or amend the General Conditions of Contract (GCC). Whenever there is a conflict, the provisions herein shall prevail over those in the GCC.

GCC 1.1(i)	The Purchaser's Country is: India
GCC 1.1(j)	The Purchaser is: Haryana Orbital Rail Corridor Limited (HORCL)
	Add at the end of Sub-Clause 1.1 The Purchaser's Representative is: Haryana Rail Infrastructure Development Corporation Limited (HRIDC)
GCC 1.1(n)	Supplier shall mean Supplier/Contractor
GCC 1.1 (o)	The Project Site(s)/Final Destination(s) is as specified in Section VII: Schedule of Requirements.
Add New Sub-Clause 1.1 (p) at the end of GCC Sub-Clause 1.1 (o)	
GCC 1.1 (p)	Engineer is: RITES Limited in Consortium with SMEC International Pty Ltd, Address: 4th Floor, Plot No.144, RITES Limited, Sector-44, Gurugram, Haryana-122003 The Engineer shall manage the Contract and shall also process payments to the Supplier.
GCC 4.2 (a)	The meaning of the trade terms shall be as prescribed by Incoterms.
GCC 4.2 (b)	The version edition of Incoterms shall be 2020 (latest updated) .
GCC 5.1	The language shall be: English

GCC 8.1	<p>For Notices,</p> <p>a) the Purchaser's address shall be:</p> <p style="padding-left: 40px;">Haryana Orbital Rail Corporation Limited, Plot No 143, 5th Floor, Railtel Tower, Sector-44, Gurugram, Haryana-122003</p> <p>b) the Engineer's address shall be:</p> <p style="padding-left: 40px;">RITES Limited in Consortium with SMEC International Pty Ltd, Address: 4th Floor, Plot No.144, RITES Limited, Sector-44, Gurugram, Haryana-122003</p> <p>c) the Supplier's address shall be: To be entered at the time of signing of Contract Agreement</p>
GCC 9.1	The governing law shall be the law of India .
GCC 10.2	<p>This clause stands amended and restated in its entirety as follows:</p> <p>10.2.1 Disputes shall be settled by arbitration in accordance with the following provisions:</p> <p>(A) In case of the Supplier being of foreign origin</p> <p>If the efforts to resolve all or any of the disputes through amicable settlement fails, then such disputes or differences, whatsoever arising between the parties, arising out of the Contract or relating to effect of the Contract or the breach thereof shall be referred to Arbitration in accordance with the following provisions:</p> <p>1. Selection of Arbitrators -Each dispute submitted by a Party to arbitration shall be heard by a sole arbitrator or an arbitration panel comprising three (3) arbitrators, in accordance with the following provisions:</p> <p>(a) Where the Parties agree that the dispute concerns a technical matter, they may agree to appoint a sole arbitrator or, failing agreement on the identity of such sole arbitrator within thirty (30) days after receipt by the other Party of the proposal of a name for such an appointment by the Party who initiated the proceedings, either Party may apply to Singapore International Arbitration Centre (SIAC) for a list of not fewer than five (5) nominees and, on receipt of such list, the Parties shall alternately strike names therefrom, and the last remaining nominee on the list shall be the sole arbitrator for the matter in dispute. If the last remaining nominee has not been determined in this manner within sixty (60) days of the date of receipt of the list by the Parties, SIAC shall appoint, upon the</p>

	<p>request of either Party and from such list or otherwise, a sole arbitrator for the matter in dispute.</p> <p>(b) Where the Parties do not agree that the dispute concerns a technical matter, the Purchaser and the Supplier shall each appoint one (1) arbitrator, and these two arbitrators shall jointly appoint a third arbitrator, who shall chair the arbitration panel. If the arbitrators named by the Parties do not succeed in appointing a third arbitrator within thirty (30) days after the latter of the two (2) arbitrators named by the Parties has been appointed, the third arbitrator shall, at the request of either Party, be appointed by SIAC.</p> <p>(c) If, in a dispute subject to paragraph (b) above, one Party fails to appoint its arbitrator within thirty (30) days after the other Party has appointed its arbitrator, the Party which has named an arbitrator may apply to the SIAC to appoint a sole arbitrator for the matter in dispute, and the arbitrator appointed pursuant to such application shall be the sole arbitrator for that dispute.</p> <p>2. Rules of Procedure - Except as otherwise stated herein, arbitration proceedings shall be conducted in accordance with the rules of procedure for arbitration of the United Nations Commission on International Trade Law (UNCITRAL) as in force on the date of this Contract.</p> <p>3. Substitute Arbitrators -If for any reason an arbitrator is unable to perform his/her function, a substitute shall be appointed in the same manner as the original arbitrator.</p> <p>4. Nationality and Qualifications of Arbitrators - The sole arbitrator or the third arbitrator appointed pursuant to paragraphs 1(a) through 1(c) above shall be an internationally recognized legal or technical expert with extensive experience in relation to the matter in dispute and shall not be a national of the Supplier's home country or of the Purchaser's home country or of the home country of any of their members or Parties or of the Government's country. For the purposes of this Clause, "home country" means any of:</p> <p>(a) the country of incorporation of the Supplier or of any of their members or Parties; or</p> <p>(b) the country in which the Supplier's or any of their members' or Parties' principal place of business is located; or</p> <p>(c) the country of nationality of a majority of the Supplier's or of any members' or Parties' shareholders; or</p> <p>(d) the country of nationality of the Sub-Contractor/Sub-Supplier concerned, where the dispute involves a subcontract.</p> <p>5. Miscellaneous - In any arbitration proceeding hereunder:</p> <p>(a) proceedings shall, unless otherwise agreed by the Parties, be held at Gurugram, India or such place as mutually agreed by both parties. The cost of Arbitration including the fees of the Arbitrator shall be borne equally by both the parties.</p> <p>(b) the English language shall be the official language for all purposes; and</p>
--	---

	<p>(c) the decision of the sole arbitrator or of a majority of the arbitrators (or of the third arbitrator if there is no such majority) shall be final and binding and shall be enforceable in any court of competent jurisdiction, and the Parties hereby waive any objections to or claims of immunity in respect of such enforcement.</p> <p>(B) In case of the Supplier being of Indian origin</p> <p>10.2.1 If the efforts to resolve all or any of the disputes through amicable settlement fail, then such disputes or differences, whatsoever arising between the parties, arising out of the Contract or relating to effect of the Contract or the breach thereof shall be referred to Arbitration in accordance with the following provisions:</p> <p>(a) The Arbitration proceedings shall be assumed to have commenced from the day, a written and valid demand for arbitration is received by Managing Director of the Purchaser (MD/HORCL).</p> <p>(b) The disputes so referred to arbitration shall be settled in accordance with the Indian Arbitration & Conciliation Act, 1996 and amended by the Arbitration and Conciliation (Amendment) Act, 2015 and any statutory modification or re-enactment thereof. Further, it is agreed between the parties as under:</p> <p>Number of Arbitrators - The Arbitral tribunal shall consist of 3 (three) arbitrators.</p> <p>1. Procedure for Appointment of Arbitrators</p> <p>The arbitrators shall be appointed as per following procedure:</p> <p>a) Within 30 days from the day when a written and valid demand for Arbitration is received by MD/HORCL, the Purchaser will forward a panel of not fewer than five (05) independent and neutral nominees to the Supplier. These names shall be obtained from those Organizations, for the purpose of nominating them as DAAB Members/Conciliator/Arbitrator, who are also not ex- employees or directly or indirectly associated with the Purchaser. The Supplier may propose another five members to add to the above list who shall not be an ex- employees or directly or indirectly associated with the Supplier. The Supplier will then give his consent for any one name out of the above panel list to be appointed as one of the arbitrators within 30 days of dispatch of the request by the Purchaser.</p>
--	--

	<p>b) The Purchaser will decide the second Arbitrator. MD/HORCL shall appoint the two Arbitrators, including the name of one Arbitrator for whom consent was given by the Supplier, within 30 days from the receipt of the consent for one name of the Arbitrator from the Supplier. In case the Supplier fails to give his consent within 30 days of the request of the Purchaser, MD/HORCL shall nominate both the Arbitrators from the panel. The third Arbitrator shall be chosen by the two Arbitrators so appointed by the parties out of the panel of Arbitrators finalized in para (a) above who shall act as presiding Arbitrator. In case of failure of the two appointed Arbitrators to reach upon consensus for the appointment of presiding Arbitrator within a period of 30 days from their appointment, then, upon the request of either or both parties, the presiding Arbitrator shall be appointed by the President of Indian Council of Arbitration, New Delhi, India.</p> <p>c) If one or more of the Arbitrators appointed as above refuses to act as Arbitrator, withdraws from his office as Arbitrator, or vacates his/their office/offices or is/are unable or unwilling to perform his functions as Arbitrator for any reason whatsoever or dies or in the opinion of the MD/HORCL fails to act without undue delay, the MD/HORCL shall appoint new Arbitrator/Arbitrators to act in his/their place except in case of new presiding Arbitrator who shall be chosen following the same procedure as mentioned in para (b) above. Such reconstituted Tribunal may, at its discretion, proceed with the reference from the stage at which it was left by the previous Arbitrator(s).</p> <p>d) The Purchaser at the time of offering the panel of Arbitrator(s) to be appointed as Arbitrator shall also supply the information with regard to the qualifications of the said Arbitrators nominated in the panel along with their professional experience, phone nos. and addresses to the Supplier. The minimum qualification and experience of the arbitrators which may be appointed by the Parties in accordance with the contract is set out below:</p> <ul style="list-style-type: none">(i) A working/retired officer (not below E-8 grade in a central public sector undertaking in India, with which the Purchaser has no direct business relationship), of engineering or accounts/finance discipline, having experience in management of construction contracts; or(ii) A retired officer (not below the SAG level in Indian Railways) of any Engineering Services of Indian Railways or Indian Railway Accounts Service, having experience in management of construction contracts;
--	--

	<p>2. Miscellaneous: In any arbitration proceeding hereunder:</p> <p>(a) The language of arbitration shall be English. This arbitration shall be governed in accordance with the laws of India.</p> <p>(b) The venue of the arbitration shall be Gurugram, India. The cost of Arbitration including the fees of the Arbitrator shall be borne equally by both the parties.</p> <p>(c) The decision of the majority of the arbitrators (or of the third arbitrator if there is no such majority) shall be final and binding and shall be enforceable in High court at Chandigarh, and the Parties hereby waive any objections to or claims of immunity in respect of such enforcement.</p> <p>21.6.2 In the event that the Supplier wishes to refer a dispute to arbitration in accordance with this Sub-Clause, it shall be required to serve a notice in this regard to the Managing Director, of the Purchaser for commencement of arbitration.</p> <p>21.6.3 Pending the submission of and/or decision on a dispute and until the arbitral award is published, the Parties shall continue to perform their respective obligations under the contract without prejudice to a final adjustment in accordance with such award.</p> <p>21.6.4 The arbitrators shall have full power to open up, review and revise any certificate, determination, instruction, opinion or valuation of the Engineer, and any decision of the DAAB, relevant to the dispute. Nothing shall disqualify representatives of the Parties and the Engineer from being called as a witness and giving evidence before the arbitrators on any matter whatsoever relevant to the dispute. However, Conciliator cannot be present as a witness by either party in the arbitral proceedings.</p> <p>21.6.5 Neither Party shall be limited in the proceedings before the arbitrators to the evidence or arguments previously put before the DAAB to obtain its decision, or to the reasons for dissatisfaction given in its Notice of Dissatisfaction.</p> <p>21.6.6 Neither party shall be limited in the proceedings before such arbitrators to the evidence or arguments put before the Engineer to obtain his decision. No decision given by the Engineer in accordance with the contract shall disqualify him from being called as a witness and giving evidence before the arbitrators on any matter, whatsoever, relevant to dispute referred to arbitration.</p> <p>21.6.7 Arbitration may be commenced prior to or after completion of the Works. The obligations of the Parties, the Engineer and the DAAB shall</p>
--	--

	not be altered by reason of any arbitration being conducted during the progress of the Works.
GCC 13.1	<p>Upon delivery of the Goods to the transporter, the Supplier shall notify the Purchaser and send the following documents to the Purchaser:</p> <ul style="list-style-type: none">(a) Two (02) copies of the Supplier's invoice showing the description of the Goods, quantity, unit price and total amount;(b) Consignee/dispatch note issued by the Agency engaged for the transportation of the Good; delivery note, railway receipt or truck receipt;(b) Manufacturer's or Supplier's warranty certificate;(c) Insurance Certificate / Insurance Policy(d) Inspection certificate issued by the nominated inspection agency, and the Supplier's factory inspection report; and(e) evidence of payment of customs duties or other similar import taxes on directly imported components incorporated in the Goods.(f) Certificate of Origin <p>The above documents shall be received by the Purchaser before the arrival of the Goods and, if not received, the Supplier will be responsible for any consequent expenses.</p>

GCC 15.1	<p>Replace entire Sub-Clause 15. 1 with the following:</p> <p>15.1.1 The Contract price shall included all duties (including Customs duties), taxes including Goods and Services Taxes (GST), insurances, transportation cost to the final destination (Project site), Inspection charges, Freight Charges, royalties, fees, cess, octroi/Entry tax, other levies payable by the Contractor under the Contract, or for any other cause, as of the date 28 days prior to the deadline for submission of Tenders shall be included in the rates, prices and the total Tender Price submitted by the Tenderer.</p> <p>15.1.2 The prices charged for the Goods supplied and the related Services performed shall be adjustable.</p> <p>Price Adjustment Formula</p> <p>The following method shall be used to calculate the price adjustment: $P_1 = (P_0 / 100) (10 + 23 I_1 / I_0 + 11 L_1 / L_0 + 21 S_1 / S_0 + 26 C_1 / C_0 + 9 W_1 / W_0)$</p> <p>Where,</p> <table border="1" style="width: 100%; border-collapse: collapse;"> <tr> <td style="width: 10%;">P₁</td> <td>Updated Rate of sleeper</td> </tr> <tr> <td>P₀</td> <td>Accepted Rate of sleeper</td> </tr> <tr> <td>I₁</td> <td>WPI for Pig Iron during production Month as per Economic Advisor, Ministry of Industry web site http:// eaindustry.nic.in</td> </tr> <tr> <td>I₀</td> <td>WPI of Pig Iron for one month before tender opening month as per Economic Advisor, Ministry of Industry Web site http://eaindustry.nic.in</td> </tr> <tr> <td>L₁</td> <td>All India Consumer Price Index of Industrial Labour during production Month, as per Labour Bureau, Ministry of Labour web site http://labourbureau.nic.in</td> </tr> <tr> <td>L₀</td> <td>All India Consumer Price Index for Industrial Labourfor one month before tender opening month as per Labour Bureau, Ministry of Labour web site http://labourbureau.nic.in</td> </tr> <tr> <td>S₁</td> <td>WPI for alloy steel wire rods during Production Month as per Economic Advisor, Ministry of Industry web site http:// eaindustry.nic. in</td> </tr> </table>	P₁	Updated Rate of sleeper	P₀	Accepted Rate of sleeper	I₁	WPI for Pig Iron during production Month as per Economic Advisor, Ministry of Industry web site http:// eaindustry.nic.in	I₀	WPI of Pig Iron for one month before tender opening month as per Economic Advisor, Ministry of Industry Web site http://eaindustry.nic.in	L₁	All India Consumer Price Index of Industrial Labour during production Month, as per Labour Bureau, Ministry of Labour web site http://labourbureau.nic.in	L₀	All India Consumer Price Index for Industrial Labourfor one month before tender opening month as per Labour Bureau, Ministry of Labour web site http://labourbureau.nic.in	S₁	WPI for alloy steel wire rods during Production Month as per Economic Advisor, Ministry of Industry web site http:// eaindustry.nic. in
P₁	Updated Rate of sleeper														
P₀	Accepted Rate of sleeper														
I₁	WPI for Pig Iron during production Month as per Economic Advisor, Ministry of Industry web site http:// eaindustry.nic.in														
I₀	WPI of Pig Iron for one month before tender opening month as per Economic Advisor, Ministry of Industry Web site http://eaindustry.nic.in														
L₁	All India Consumer Price Index of Industrial Labour during production Month, as per Labour Bureau, Ministry of Labour web site http://labourbureau.nic.in														
L₀	All India Consumer Price Index for Industrial Labourfor one month before tender opening month as per Labour Bureau, Ministry of Labour web site http://labourbureau.nic.in														
S₁	WPI for alloy steel wire rods during Production Month as per Economic Advisor, Ministry of Industry web site http:// eaindustry.nic. in														

	So	WPI for alloy steel wire rods for one month before tender opening month as per Economic Advisor, Ministry of Industry web site http://eaindustry.nic.in
	C₁	WPI for “Ordinary Portland Cement” during production month as per Economic Adviser, Ministry of Industry website http://eaindustry.nic.in/
	Co	WPI for “Ordinary Portland Cement” one month before tender opening month as per Economic Adviser, Ministry of Industry website http://eaindustry.nic.in/
	W₁	WPI for all commodities during production Month as per Economic Advisor, Ministry of Industry web site http://eaindustry.nic.in
	Wo	WPI for all commodities for one month before tender opening month, as per Economic Advisor, Ministry of Industry web site http://eaindustry.nic.in
	<p>15.1.3 In order to avoid blockage of funds till final escalation is worked out and paid on the basis of indices for the month of production, the accepted price will be updated every six months as per the above formula for escalation. First updating shall be done on the basis of indices for the month of acceptance of tender as soon as confirmed indices for the month of acceptance are available. Payment for the supplies made shall be done at the latest updated price.</p> <p>15.1.4 No price adjustment shall be payable on the portion of the Contract Price paid to the Supplier as advance payment.</p>	
GCC 16.1	<p>Replace entire Sub-Clause 16.1 with the following:</p> <p>16.1.1 The time to time interim payment towards supply of finished goods shall be made at the updated rate. The final payment would be made as per Escalated/De-escalated rate worked out on the basis of Price Variation Clause (Clause 13). All payments will be made by the HORCL/HRIDC on submission of bills in accordance with the procedure as detailed below:</p> <p>16.1.2 70% of the price of each consignment will be paid after the PSC sleepers are inspected and passed by the Purchaser on execution of Indemnity Bond in the prescribed format given in Section X- Contract Forms for an equivalent amount by the Supplier. In such</p>	

	<p>cases of 70% advance payments, a copy of the Inspection Certificate shall be enclosed with the bills. The Supplier may submit the Indemnity Bond for 70% of the contract value in one go in lieu of submitting several Indemnity Bonds for 70% of value of each inspected consignment.</p> <p>16.1.3 Balance 30% of the price of each consignment will be paid on proof of dispatch and on submission of Indemnity Bond (in the prescribed format given in Section X-Contract Forms for 25% of the value of stores supplied covering the warranty period as per warranty clause. The Supplier may submit the Indemnity Bond for 25% value of the entire value of the contract in one go in lieu of submitting several Indemnity Bonds for 25% of each consignment. Consignor's Certificate shall be enclosed with 30% bills. In case, 70% payment as laid down in clause 15.2 above is not sought, 100% of the price of each consignment will be paid on proof of dispatch of stores and on submission of Indemnity Bond.</p> <p>16.1.4 All payments shall be subject to the deduction of any amount for which the Supplier is liable under this contract or any other contract in respect of which the HRIDC/HORCL/President of India is the Purchaser and any other deductions as are legally leviable as per Indian laws.</p> <p>16.1.5 Payment of Goods and Service Taxes (GST)</p> <p>The Supplier is responsible for paying all the taxes [including Goods and Service Tax (GST)], duties, cess, etc. as per the Statutory requirements. However, GST levied on the invoices raised by the Supplier will be temporarily withheld at the time of making payment for the invoice.</p> <p>GST withheld will be released by HRIDC/ HORCL on submission of proof, i.e. copy of Form GSTR-1 (reflecting the particular invoice) after due verification from the GST portal by the Purchaser.</p>
GCC 16.4	<p>Add the following at the end of Sub-Clause 16.4:</p> <p>The currency for payments shall be as per Table B Summary of payment of Currencies in Section IV Tender Forms, Part 1</p>

GCC 16.5	<p>The payment-delay period after which the Purchaser shall pay interest to the supplier shall be 28 days.</p> <p>The interest rate shall be calculated at an interest rate equal to “State Bank of India’s (SBI) Marginal Cost of fund-based Lending Rate (MCLR)” applicable for the tenure of 01year prevailing on the due date plus three percent.</p>
GCC 18.1	<p>Replace Sub-Clause 18.1 with the following:</p> <p>The Supplier shall, within twenty-eight (28) days of the notification of contract award, provide performance security for the performance of the Contract. The amount of performance security shall be 5% of the Accepted Contract Amount and in the same currency (ies) of the Accepted Contract Amount.</p> <p>In the event the Supplier fails to provide the Performance Security within 28 days from the date of issue of the LOA, it may seek an extension of time for providing the performance security for a period not exceeding a further 14 days on payment of damages for such extended period in a sum calculated at the rate of 0.005% of the Accepted Contract Amount for each day until the Performance Security is provided. The Supplier shall maintain the said Performance Security at its own expense, so that it shall remain in full force and effect until the issue of Performance Certificate. In the event of a revision of the Contract Price, the value of the Performance Security shall be increased proportionately by the Supplier, if required by the Purchaser. The cost of obtaining the Performance Security shall be at the expense of the Supplier.</p>

GCC 18.3	<p>The Supplier shall submit the Performance Security in any of the following forms:</p> <p>(a) Unconditional and irrevocable Bank Guarantee from the specified banks in the form appearing in Section X [Contract Forms] as under:</p> <p>(i) a scheduled bank (excluding co-operative banks) in India, or</p> <p>(ii) a Foreign Bank having arrangement with a nationalized bank or scheduled banks (excluding co-operative banks) in India;</p> <p>(b) Banker's Cheque or Demand Draft drawn on a scheduled bank (excluding co-operative banks) or nationalized bank in India.</p> <p>The scheduled bank issuing the bank guarantee shall be on “Structure Financial Messaging System (SFMS)” platform. A separate advice of the bank guarantee shall invariably be sent by the issuing bank to Purchaser’s Bank through SFMS and only of the same by the Purchaser’s Bank, the bank guarantee shall become operative and acceptable to the Purchaser. Further, the bank guarantees in original form along with a copy of “MT760COV (in case of bank guarantee message)/ MT767COV (in case of bank guarantee amendment message) Report” sent by the concerned issuing bank sealed in an envelope shall be submitted to the Purchaser.</p> <p>The Issuing Bank shall send the SFMS to:</p> <p>Beneficiary: Haryana Orbital Rail Corporation Limited</p> <p>Bank Name:</p> <p>IFSC Code:</p> <p>Note: All the instruments mentioned in (a) & (b) above should be in favour of Haryana Orbital Rail Corporation Limited, Plot No 143, 5th Floor, Railtel Tower, Sector-44, Gurugram.</p> <p>The Supplier shall ensure that the Performance Security is valid and enforceable until the Supplier has executed and completed the Works and remedied defects, if any. If, (a) the Supplier does not complete the Works for any reasons whatsoever, and (b) the Supplier has not become entitled to receive the Performance Certificate by 28 days prior to the</p>
-----------------	---

	<p>expiry date of the Performance Security, the Supplier shall be bound to extend the validity of the Performance Security until the Works have been completed and the defects have been remedied. If the Performance Security is or becomes invalid or unenforceable for any reason whatsoever, or if such security is withdrawn or expires, the Supplier must immediately notify the Purchaser and obtain within 3 days a replacement guarantee in the form appearing in Section X [Contract Forms] and which is acceptable to the Purchaser in its absolute discretion.</p> <p>The provision, maintenance and renewal by the Supplier of the Performance Security in accordance with this Sub-Clause 18.1 [Performance Security] shall be a condition precedent to any payment by the Purchaser to the Supplier under the Contract.</p> <p>If the Supplier fails to provide, maintain and renew the Performance Security in accordance with the Contract, the Purchaser shall, without prejudice to any other rights and remedies to which it may be entitled, shall have the right to invoke the Performance Security for the value equal to the damages to the Purchaser as a result of the Supplier's failure and/or by written notice terminate the Contract in accordance with Clause 35.</p>
GCC 18.4	Discharge of the Performance Security shall take place 28 days after the completion of warranty period under the Contract.
GCC 23.2	Stamping and marking of PSC sleepers will be as per Para 6 of IRS-T-39, Indian Railway Standard Specification for Pre-tensioned Pre-stressed Concrete Sleepers.
GCC 24.1	The insurance coverage shall be as specified in the Incoterms.
GCC 25.1	The Supplier is required under the Contract to transport the Goods to the place of final destination specified within the Section VII-Schedule of Requirements within the Purchaser's Country, defined as the Project Site. The transport to such place of destination in the Purchaser's Country, including insurance and storage, shall be arranged by the Supplier, and related costs shall be included in the Contract Price.
GCC 25.2	<p>Replace Sub-Clause 25 with the following</p> <p>Incidental services to be provided are: as per Section VII : Schedule of Requirements.</p>

GCC 26.1	The inspections and tests shall be as specified in Section VII: Schedule of Requirements.
GCC 26.2	The inspections and tests shall be conducted at location specified in Section VII: Schedule of Requirements.

GCC 27.1	<p>Replace GCC 27.1 with the following</p> <p>If the Supplier fails to deliver the store within the delivery period as per contract or as extended or at any time repudiates the contract before the expiry of such period due to any circumstances whatsoever, save as provided in sub Clause (e), and force majeure conditions defined in Clause 32, the purchaser reserves the right to cancel the contract for the balance quantity in whole or in part and recover from him the liquidated damages as per sub Clause (g). If, however, the stores are accepted after the expiry of the period fixed for delivery, the purchaser may grant an extension of the delivery period at its sole discretion, subject to the following conditions:</p> <ul style="list-style-type: none">(a) That the purchaser has the right to recover from the Supplier as agreed liquidated damages and not by way of penalty a sum equivalent to ½ (half) per cent of the price of any goods (including elements of taxes, duties, freight, etc.) which the Supplier has failed to deliver within the period fixed for delivery in the contract for each week or part of a week during which the delivery of such goods may be in arrears where delivery thereof is accepted after expiry of the aforesaid period. Upper limit for recovery of liquidated Damages in Supply Contracts will be 5 % (Five Per cent) of value of delayed supplies irrespective of delays, unless otherwise provided, specifically in the contract;(b) That no increase in price on account of any statutory increase in or fresh imposition of Customs Duty, Excise Duty, Sales Tax, Freight Charges or on any account of any other tax or duty leviable in respect of the stores specified in the contract, which takes place after the date of delivery period stipulated in the said Acceptance of Tender shall be admissible on such of the said stores as are delivered after said date;(c) That notwithstanding any stipulation in the contract for increase in price on any other grounds no such increase which takes place after the delivery date stipulated in the contract shall be admissible on such of the said as are delivered after the said date;(d) But nevertheless the purchaser shall be entitled to the benefit of any decrease in price on account of reduction in or remission of Customs Duty, Excise Duty, Sales Tax or on account of any other ground which takes place after the expiry of the above mentioned date
-----------------	---

	<p>namely the delivery date stipulated in the contract. The Supplier shall allow the said benefit in his bills or in the absence thereof shall certify that no decrease in price on account of any of these factors has taken place.</p> <p>(e) If unsupplied quantities at the expiry of DP/extended DP are within 5% of the contracted quantity, then the same will be treated as cancelled without financial repercussion on either side”.</p> <p>(f) <u>Damages for slower supplies during “Monitoring Period”:</u></p> <p>The performance of delivery of sleepers will be reviewed after every 3 months. In case of failure on the part of the supplier to arrange supplies as per the specified delivery schedule fixed in advance, save force majeure conditions and/or cases of delays attributable to the HORCL, the purchaser reserves the right to cancel the quantity in deficit at the end of monitoring periods i.e. every three month and recover from the defaulting Supplier a sum equivalent to five percent of the cost of sleepers which have remained unsupplied. The recovery of five percent as detailed above will be effected only when HORCL cancel the quantities in deficit at the end of monitoring period through a written order to this effect. In case, HORCL do not cancel the quantities in deficit at the end of monitoring period, the supplier will be entitled to recoup the shortfall in subsequent monitoring period(s) and in such cases LD shall be leviable.</p> <p>(g) <u>Liquidated Damages (LD) for Failure to Complete Supplies within Delivery Period and Damages on Termination of Contract</u></p> <p>The Liquidated damages will be limited to a maximum of 5% of the cost of stores which the Supplier fails to deliver within the period fixed for delivery in the contract or as extended, where delivery of the store is accepted after expiry of the aforesaid period. In case, the delivery of the store is not accepted by the purchaser after expiry of the period fixed for delivery in the contract or as extended or the contract is terminated before expiry of the contract due to failure of the Supplier to execute the contract as per the agreed terms and conditions of the contract during its currency, the damages equivalent to 5% of the cost of sleepers undelivered/cancelled would be recovered from the Supplier.</p>
GCC 28.3	<p>Replace complete Sub-Clause GCC 28.3 with the following:</p> <p>28.3 The warranty period shall be as follows-</p>

	<p>28.3.1 The Supplier guarantees that the PSC Sleepers which he supplies shall be manufactured fully in accordance with specifications. In all cases, the Supplier guarantees that its design shall strictly follow the “as made” detailed drawing with such modifications as are notified in respect of each type.</p> <p>28.3.2 The Supplier further guarantees that the PSC sleepers shall be free from defects in material and workmanship. The Supplier shall be liable to arrange the necessary replacements of the defective sleepers free of any charge only to the extent that such replacements are attributable to or arise from faulty workmanship or material or design in the manufacture of the sleepers. All replacements shall be made free of cost at destination. If the Supplier so desires, the replaced sleepers can be taken over by him for disposal as he deems fit, within a period of three months from the date of receipt of the replacement of defective sleepers by the purchaser. At the expiry of this period, no claim in this respect shall lie on the purchaser. The guarantee herein contained shall not apply to any material which shall have been repaired or altered by the Purchaser, or on his behalf in any way so as to effect its strength, performance or reliability, or to any defect to any part due to misuse, negligence or accident.</p> <p>28.3.3 The guarantee herein contained shall expire in respect of each sleeper on the expiry of five years from the date of the manufacturing / three years from date of placement in service, whichever is earlier, except in respect of defects notified to the Supplier prior to the expiry of such date. Provisions of IRS T-39 in this regard shall also be applied.</p> <p>28.3.4 All replacements that the purchaser shall call upon the Supplier to deliver under this guarantee shall be delivered by the Supplier within 60 days from the date of intimation of such rejection of defective sleepers. If the Supplier fails to replace the defective sleepers within the said period, the cost of the said sleepers at the rate stipulated in the contract shall be recovered from the payments due to the Supplier.</p> <p>28.3.5 Any approval of acceptance by the purchaser of the sleepers or of the materials, incorporated therein shall not in any way limit the Supplier’s liability hereunder.</p> <p>28.3.6 The decision of the purchaser in regard to Supplier’s liability under this guarantee shall be final and conclusive.</p>
--	--

GCC 28.5, GCC 28.6	The period for replacement shall be as detailed in Sub-Clause 28.3 Special Conditions of Contract.
GCC 33.4	Not Applicable

Section X - Contract Forms

Forms

Notification of Intention to Award.....44

Beneficial Ownership Disclosure Form.....48

Letter of Acceptance.....51

Contract Agreement.....52

Performance Security54

Advance Payment Security56

Notification of Intention to Award

[This Notification of Intention to Award shall be sent to each Tenderer that submitted a Tender.]

[Send this Notification to the Tenderer's Authorized Representative named in the Tenderer Information Form]

For the attention of Tenderer's Authorized Representative

Name: *[insert Authorized Representative's name]*

Address: *[insert Authorized Representative's Address]*

Telephone/Fax numbers: *[insert Authorized Representative's telephone/fax numbers]*

Email Address: *[insert Authorized Representative's email address]*

[IMPORTANT: insert below the date that this Notification is transmitted to Tenderers. The Notification must be sent to all Tenderers simultaneously. This means on the same date and as close to the same time as possible.]

DATE OF TRANSMISSION: This Notification is sent by: *[email/fax]* on *[date]* (local time)

Notification of Intention to Award

Purchaser: *[insert the name of the Purchaser]*

Project: *[insert name of project]*

Contract title: *[insert the name of the contract]*

Country: *[insert country where Tender is issued]*

Loan No.: *[insert reference number for loan/credit/grant]*

Tender No: *[insert the Tender reference number from Procurement Plan]*

This Notification of Intention to Award (Notification) notifies you of our decision to award the above contract. The transmission of this Notification begins the Standstill Period. During the Standstill Period you may:

- a) request a debriefing in relation to the evaluation of your Tender; and/or
- b) submit a Procurement-Related Complaint in relation to the decision to award the contract.

1. The successful Tenderer

Name:	<i>[insert name of successful Tenderer]</i>
Address:	<i>[insert address of the successful Tenderer]</i>
Contract price:	<i>[insert contract price of the successful Tender]</i>

2. List of all Tenderers [INSTRUCTIONS: insert names of all Tenderers that submitted a Tender including the successful Tenderer, together with the corresponding Tender price as read out at tender opening and the evaluated Tender price (if applicable).]

Name of Tenderer	Tender Price	Evaluated Tender Price (if applicable)
[insert name]	[insert Tender price]	[insert evaluated price]
[insert name]	[insert Tender price]	[insert evaluated price]
[insert name]	[insert Tender price]	[insert evaluated price]
[insert name]	[insert Tender price]	[insert evaluated price]
[insert name]	[insert Tender price]	[insert evaluated price]

3. Reason/s why your Tender was unsuccessful

[INSTRUCTIONS: State the reason/s why this Tenderer's Tender was unsuccessful. Do NOT include: (a) a point-by-point comparison with another Tenderer's Tender or (b) information that is marked confidential by the Tenderer in its Tender.]

4. How to request a debriefing

DEADLINE: The deadline to request a debriefing expires at midnight on [insert date] (local time).

You may request a debriefing in relation to the results of the evaluation of your Tender. If you decide to request a debriefing your written request must be made within three (3) Business Days of receipt of this Notification of Intention to Award.

Provide the contract name, reference number, name of the Tenderer, contact details; and address the request for debriefing as follows:

Attention: [insert full name of person, if applicable]

Title/position: [insert title/position]

Agency: [insert name of Purchaser]

Email address: [insert email address]

Fax number: [insert fax number] **delete if not used**

If your request for a debriefing is received within the three (3)-Business Day deadline, we will provide the debriefing within five (5) Business Days of receipt of your request. If we are unable to provide the debriefing within this period, the Standstill Period shall be

extended by five (5) Business Days after the date that the debriefing is provided. If this happens, we will notify you and confirm the date that the extended Standstill Period will end.

The debriefing may be in writing, by phone, video conference call or in person. We shall promptly advise you in writing how the debriefing will take place and confirm the date and time.

If the deadline to request a debriefing has expired, you may still request a debriefing. In this case, we will provide the debriefing as soon as practicable, and normally no later than fifteen (15) Business Days from the date of publication of the Contract Award Notice.

5. How to make a complaint

Period: Procurement-Related Complaint challenging the decision to award shall be submitted by midnight, [*insert date*] (local time).

Provide the contract name, reference number, name of the Tenderer, contact details; and address the Procurement-related Complaint as follows:

Attention: [*insert full name of person, if applicable*]

Title/position: [*insert title/position*]

Agency: [*insert name of Purchaser*]

Email address: [*insert email address*]

Fax number: [*insert fax number*] **delete if not used**

At this point in the procurement process, you may submit a Procurement-Related Complaint challenging the decision to award the contract. You do not need to have requested, or received, a debriefing before making this complaint. Your complaint must be submitted within the Standstill Period and received by us before the Standstill Period ends.

For more information see the [Procurement Instructions for Recipients](#) (Annex IV, Complaint Monitoring).

6. Standstill Period

DEADLINE: The Standstill Period is due to end at midnight on [*insert date*] (local time).

The Standstill Period lasts ten (10) Business Days after the date of transmission of this Notification of Intention to Award.

The Standstill Period may be extended as stated in Section 4 above.

If you have any questions regarding this Notification please do not hesitate to contact us.

For and on behalf of the Purchaser:

Signature: _____

Name: _____

Title/Position: _____

Telephone: _____

Email: _____

Beneficial Ownership Disclosure Form

INSTRUCTIONS TO TENDERERS: DELETE THIS BOX ONCE YOU HAVE COMPLETED THE FORM

This Beneficial Ownership Disclosure Form ("Form") is to be completed by the successful Tenderer¹. In case of joint venture, the Tenderer must submit a separate Form for each member. The beneficial ownership information to be submitted in this Form shall be current as of the date of its submission.

For the purposes of this Form, a Beneficial Owner of a Tenderer is any natural person who ultimately owns or controls the Tenderer by meeting one or more of the following conditions:

- *directly or indirectly holding 25 percent or more of the shares,*
- *directly or indirectly holding 25 percent or more of the voting rights or*
- *directly or indirectly having the right to appoint a majority of the board of directors or equivalent governing body of the Tenderer.*

Tender No.: *[insert number of Tendering process]*

Tender Name: *[insert title of the Tender Document]*

To: *[insert complete name of Purchaser]*

In response to your request in the Letter of Acceptance dated *[insert date of letter of Acceptance]* to furnish additional information on beneficial ownership:

[select one of the options described below as applicable and delete the other options that are not applicable]

(i) we hereby provide the following beneficial ownership information.

Details of beneficial ownership

Identity of Beneficial Owner	Directly or indirectly holding 25 percent or more of the shares (Yes / No)	Directly or indirectly holding 25 percent or more of the Voting Rights (Yes / No)	Directly or indirectly having the right to appoint a majority of the board of the directors or an equivalent governing body of the Tenderer (Yes / No)

[include full name (last, middle, first), nationality, country of residence]			
--	--	--	--

OR

(ii) We declare that there is no Beneficial Owner meeting one or more of the following conditions:

- directly or indirectly holding 25 percent or more of the shares,
- directly or indirectly holding 25 percent or more of the voting rights or
- directly or indirectly having the right to appoint a majority of the board of directors or equivalent governing body of the Tenderer

OR

(iii) We declare that we are unable to identify any Beneficial Owner meeting one or more of the following conditions. [If this option is selected, the Tenderer shall provide explanation on why it is unable to identify any Beneficial Owner]

- directly or indirectly holding 25 percent or more of the shares,
- directly or indirectly holding 25 percent or more of the voting rights or
- directly or indirectly having the right to appoint a majority of the board of directors or equivalent governing body of the Tenderer]

Name of the Tenderer:* [insert complete name of the Tenderer] _____

Name of the person duly authorized to sign the Tender on behalf of the Tenderer:** [insert complete name of person duly authorized to sign the Tender]_____

Title of the person signing the Tender: [insert complete title of the person signing the Tender]

Signature of the person named above: [insert signature of person whose name and capacity are shown above] _____

Date signed [insert date of signing] **day of** [insert month], [insert year]

*In the case of the Tender submitted by a Joint Venture, specify the name of the Joint Venture as Tenderer. In the event that the Tenderer is a joint venture, each reference to "Tenderer" in the Beneficial Ownership Disclosure Form (including this Introduction thereto) shall be read to refer to the joint venture member.

** Person signing the Tender shall have the power of attorney given by the Tenderer. The power of attorney shall be attached with the Tender Schedules.

Letter of Acceptance

[use letterhead paper of the Purchaser]

[date]

To: *[name and address of the Supplier]*

Subject: **Notification of Award Contract No.**

This is to notify you that your Tender dated ***[insert date]*** for execution of the ***[insert name of the contract and identification number, as given in the SCC]*** for the Contract Price of ***[insert amount in numbers and words and name of currency]***, as corrected and modified in accordance with the Instructions to Tenderers is hereby accepted by our Agency.

You are requested to furnish (i) the Performance Security within 28 days in accordance with the Conditions of Contract, using for that purpose the Performance Security Form; and (ii) the additional information on beneficial ownership in accordance with TDS ITT 45.1 within eight (8) Business days using the Beneficial Ownership Disclosure Form, included in Section X, Contract Forms, of the Tender Document.

Authorized Signature: _____

Name and Title of Signatory: _____

Name of Agency: _____

Attachment: Contract Agreement

Contract Agreement

[The successful Tenderer shall fill in this form in accordance with the instructions indicated]

THIS AGREEMENT made the *[insert: **number**]* day of *[insert: **month**]*, *[insert: **year**]*.

BETWEEN

- (1) *[insert complete name of Purchaser]*, a *[insert description of type of legal entity, for example, an agency of the Ministry of ... of the Government of {insert name of Country of Purchaser}, or corporation incorporated under the laws of {insert name of Country of Purchaser}]* and having its principal place of business at *[insert address of Purchaser]* (hereinafter called “the Purchaser”), of the one part, and
- (2) *[insert name of Supplier]*, a corporation incorporated under the laws of *[insert: country of Supplier]* and having its principal place of business at *[insert: address of Supplier]* (hereinafter called “the Supplier”), of the other part:

WHEREAS the Purchaser invited Tenders for certain Goods and Related Services, viz., *[insert brief description of Goods and Related Services]* and has accepted a Tender by the Supplier for the supply of those Goods and Related Services, in the sum of *[insert currency or currencies and amount of contract price in figures and words]* (hereinafter called “the Contract Price”).

The Purchaser and the Supplier agree as follows:

1. In this Agreement words and expressions shall have the same meanings as are respectively assigned to them in the Contract documents referred to.
2. The following documents shall be deemed to form and be read and construed as part of this Agreement. This Agreement shall prevail over all other contract documents:
 - (a) the Letter of Acceptance,
 - (b) the Letter of Tender,
 - (c) the Addenda Nos. _____ (if any),
 - (d) the Special Conditions of Contract,
 - (e) the General Conditions of Contract,
 - (f) the Schedule of Supply (including Schedule of Requirements and Technical Specifications),
 - (g) the completed Schedules (including Price Schedules) and
 - (h) any other document listed in GCC as forming part of the Contract.
3. In consideration of the payments to be made by the Purchaser to the Supplier as specified in this Agreement, the Supplier hereby covenants with the Purchaser to supply the Goods and Related

Services and to remedy defects therein in conformity in all respects with the provisions of the Contract.

4. The Purchaser hereby covenants to pay the Supplier in consideration of the supply of the Goods and Related Services and the remedying of defects therein, the Contract Price or such other sum as may become payable under the provisions of the Contract at the times and in the manner prescribed by the Contract.

IN WITNESS whereof the parties hereto have caused this Agreement to be executed in accordance with the laws of *[insert the name of the Contract governing law country]* on the day, month and year indicated above.

For and on behalf of the Purchaser

Signed: *[insert signature]*
in the capacity of *[insert title or other appropriate designation]*
In the presence of *[insert identification of official witness]*

For and on behalf of the Supplier

Signed: *[insert signature of authorized representative(s) of the Supplier]*
in the capacity of *[insert title or other appropriate designation]*
in the presence of *[insert identification of official witness]*

**Performance Security
Bank Guarantee**

[The bank, as requested by the successful Tenderer, shall fill in this form in accordance with the instructions indicated]

[Guarantor letterhead or SWIFT identifier code]

Beneficiary: *[insert name and address of the Purchaser]*

Date: ____ *[Insert date of issue]*

PERFORMANCE GUARANTEE NO.: *[Insert guarantee reference number]*

Guarantor: *[Insert name and address of place of issue, unless indicated in the letterhead]*

We have been informed that _ *[insert name of Supplier, which in the case of a joint venture shall be the name of the joint venture]* (hereinafter called "the Applicant") has entered into Contract No. *[insert reference number of the contract]* dated *[insert date]* with the Beneficiary, for the supply of _ *[insert name of contract and brief description of Goods and Related Services]* (hereinafter called "the Contract").

Furthermore, we understand that, according to the conditions of the Contract, a Performance Guarantee is required.

At the request of the Applicant, we as Guarantor, hereby irrevocably undertake to pay the Beneficiary any sum or sums not exceeding in total an amount of *[insert amount in figures]* (*[insert amount in words]*),¹ such sum being payable in the types and proportions of currencies in which the Contract Price is payable, upon receipt by us of the Beneficiary's complying demand supported by the Beneficiary's statement, whether in the demand itself or in a separate signed document accompanying or identifying the demand, stating that the Applicant is in breach of its obligation(s) under the Contract, without the Beneficiary needing to prove or to show grounds for your demand or the sum specified therein.

This guarantee shall expire, no later than the Day of, 2...², and any demand for payment under it must be received by us at this office indicated above on or before that date.

¹ *The Guarantor shall insert the amount(s) specified in the SCC and denominated, as specified in the SCC, either in the currency (ies) of the Contract or a freely convertible currency acceptable to the Beneficiary.*

² *Insert the date twenty-eight (28) days after the expected completion date as described in GCC Clause 18.4. The Purchaser should note that in the event of an extension of this date for completion of the Contract, the Purchaser would need to request an extension of this guarantee from the Guarantor. Such request must be in writing and must be made prior to the expiration date established in the guarantee. In preparing this guarantee, the Purchaser might consider adding the following text to the form, at the end of the penultimate paragraph: "The Guarantor agrees to a one-time extension of this guarantee for a period not to exceed [six months] [one year], in response to the Beneficiary's written request for such extension, such request to be presented to the Guarantor before the expiry of the guarantee."*

This guarantee is subject to the Uniform Rules for Demand Guarantees (URDG) 2010 Revision, ICC Publication No. 758, except that the supporting statement under Article 15(a) is hereby excluded.

[signature(s)]

Note: All italicized text (including footnotes) is for use in preparing this form and shall be deleted from the final product.

Advance Payment Security

Demand Guarantee

[Guarantor letterhead or SWIFT identifier code]

Beneficiary: *[Insert name and Address of Purchaser]*

Date: *[Insert date of issue]*

ADVANCE PAYMENT GUARANTEE No.: *[Insert guarantee reference number]*

Guarantor: *[Insert name and address of place of issue, unless indicated in the letterhead]*

We have been informed that *[insert name of Supplier, which in the case of a joint venture shall be the name of the joint venture]* (hereinafter called "the Applicant") has entered into Contract No. *[insert reference number of the contract]* dated *[insert date]* with the Beneficiary, for the execution of *[insert name of contract and brief description of Goods and Related Services]* (hereinafter called "the Contract").

Furthermore, we understand that, according to the conditions of the Contract, an advance payment in the sum of *[insert amount in figures]* (_____) *[insert amount in words]* is to be made against an advance payment guarantee.

At the request of the Applicant, we as Guarantor, hereby irrevocably undertake to pay the Beneficiary any sum or sums not exceeding in total an amount of *[insert amount in figures]* () *[insert amount in words]*¹ upon receipt by us of the Beneficiary's complying demand supported by the Beneficiary's statement, whether in the demand itself or in a separate signed document accompanying or identifying the demand, stating either that the Applicant:

- (a) has used the advance payment for purposes other than toward delivery of Goods; or
- (b) has failed to repay the advance payment in accordance with the Contract conditions, specifying the amount which the Applicant has failed to repay.

A demand under this guarantee may be presented as from the presentation to the Guarantor of a certificate from the Beneficiary's bank stating that the advance payment referred to above has been credited to the Applicant on its account number *[insert number]* at *[insert name and address of Applicant's bank]*.

¹ *The Guarantor shall insert an amount representing the amount of the advance payment and denominated either in the currency(ies) of the advance payment as specified in the Contract, or in a freely convertible currency acceptable to the Purchaser.*

The maximum amount of this guarantee shall be progressively reduced by the amount of the advance payment repaid by the Applicant as specified in copies of interim statements or payment certificates which shall be presented to us. This guarantee shall expire, at the latest, upon our receipt of a copy of the interim payment certificate indicating that ninety (90) percent of the Contract Price, has been certified for payment, or on the *[insert day]* day of *[insert month]*, *[insert year]*, whichever is earlier. Consequently, any demand for payment under this guarantee must be received by us at this office on or before that date.

This guarantee is subject to the Uniform Rules for Demand Guarantees (URDG) 2010 Revision, ICC Publication No.758, except that the supporting statement under Article 15(a) is hereby excluded.

[signature(s)]

Note: All italicized text (including footnotes) is for use in preparing this form and shall be deleted from the final product.

INDEMNITY BOND

(For 70% payment of value of Mono Block PSC Concrete Sleepers inspected and Accepted by the Purchaser)

To,

Haryana Orbital Rail Corporation Limited

THIS INDENTURE made on this day ___ by M/s. (Duly registered under the Indian Companies Act 1956) and having its registered office at _____, hereinafter called “the Supplier” (which expression shall include its successors) in favour of the Haryana Orbital Rail Corporation Limited (HORCL), hereinafter called “the Purchaser” (which expression shall include his successors and assignees).

WHERE AS under the formal order/contract specified in schedule, I/We have agreed to supply mono block concrete sleepers to the HORCL (hereinafter called the Purchaser) at the time and place and in the manner detailed there in.

WHERE AS purchaser agreed to accommodate the Supplier in case in which the purchaser thinks fit by making 70% payment of value of Mono block PSC Concrete Sleepers which have been inspected and passed by the Purchaser or his nominee.

In consideration of such payment I/We am/are hereby is/are expressly prepared to accept certain liabilities as herein after set out but such liabilities shall not affect the passing of the sleepers concerned to the purchaser.

NOW, I/We hereby agree, declare and undertake as follows:

- (i) I/We shall remain absolutely responsible for the safe custody and protection of sleepers, which were inspected and passed by the Railway Authority _____ by IC No. _____ dated, but could not be dispatched due to non-availability of truck/wagons against all risk whatsoever, till those are dispatched under the above mentioned contract and duly delivered. The HORCL, however, shall be kept indemnified against any losses and/or damage to the said sleepers till delivery to the ultimate consignee. The said sleepers shall however, be at all-time open to the inspection by officer who may be authorized on behalf, by the purchaser or his nominee.

- (ii) Details of quantity which will be loaded in my/our siding as per challan will be submitted by me/us to the consignee direct and if any discrepancy is noticed on receipt of Mono block Concrete Sleepers at the destination, the cost of quantity in deficit will be realized from my/our 30% bills.
- (iii) The said number of sleepers shall be loaded and dispatched correctly as per the inspection note and that no broken or un-passed sleepers, not conforming to the specification/drawings mentioned in the formal contract shall be dispatched and then in such case we shall be liable for the entire loss or damage that purchaser may sustain due to the dispatch of such broken/un-passed sleepers and I/We undertake to indemnify the purchaser against all such loss and damage and shall replace at my/our cost any of such broken/un-passed sleepers as may be dispatched by us aforesaid.
- (iv) In the event of any loss or damage as aforesaid the assessment of such loss or damage and assessment of the compensation therefore would be made by the GM/IP&IT, HORCL or his authorized nominee from our 30% bills and the said assessment shall be final and binding upon us.
- (v) Provided always that notwithstanding anything contained in the formal, order/contract, the HORCL will be fully entitled to realize all dues against me/us under orders/contracts specified in the schedule or other contracts between myself/ourselves and the HORCL without prejudice due by any other lawful means.

THE SCHEDULE

HORCL's acceptance letter No. _____ dated _____ and HORCL's contract Agreement No. _____ dated _____ for manufacture and supply of Mono block PSC Concrete Sleepers.

Witness:

*Signature of the Supplier /supplier:

Address:Dated:

Name:

Address:

Dated:

HORCL

FOR AND ON BEHALF OF HORCL

INDEMNITY BOND

(For 30% payment of value of Mono Block PSC Concrete Sleepers inspected and Accepted by the Purchaser)

1. BY THE PRESENT INDEMNITY BOND executed by M/s ----- on this _____ day of _____ 20____ (hereinafter called the “Supplier”) in favour of Haryana Orbital Rail Corporation Limited (HORCL) hereinafter called the “Purchaser”.

2. WHEREAS – The Supplier has agreed with the purchaser to manufacture and supply PSC mono block Line Sleepers to the HORCL Administration in pursuant to and in terms of a contract evidenced by the----- =====.

3. AND WHEREAS pursuant to the said contract, the Supplier(s) commenced dispatches of sleepers on _____ and completed dispatches by -----

4. AND WHEREAS under ----- of the said contract for the supply of PSC monoblock Line Sleepers payment for the delivery of stores was/is to be made as follows:

Balance 30% of the price of each consignment will be paid on receipt of stores at consignee’s end duly certified by a nominated officer of the consignee and on submission of a Bond for 25% of the value of Stores supplied covering the warranty period as per warranty clause. Consigner’s certificate shall be enclosed with 30% bills. In case 70% payment as laid down in **Clause**-----above is not sought, 100% of price of each consignment will be paid on receipt of stores at consignee’s end duly certified by a nominated officer of the consignee and on submission of Indemnity Bond.

AND WHEREAS 70% payment in respect of the Stores inspected has already been paid by the -----HORCL to the Supplier, vide Cheque No.-- -----dated _____Rs.-----.

5. AND WHEREAS the Supplier submitted one of his bills being bill No. ----- of Rs.----- for the 30% (i.e. balance amount) of the value in respect of stores dispatched by him through Way Bill No ----- to the consignee thereof namely the -----.

6. AND WHEREAS the Supplier submitted one of his bills being bill No.----- of _____Rs.----- for . the 30% (i.e. balance amount) of the value in respect of stores dispatched by him through Way Bill No. to the consignee thereof namely

the.....

7. AND WHEREAS the Purchaser has agreed to pay the amount of Rs (in words).....being the 30% /100% of the said bill No.----- upon the Supplier subject to execute an indemnity bond in the manner hereafter provided in the para----- of the contract.

8. NOW THEREFORE through this indenture, the Supplier hereby covenants with the Purchaser that the Supplier shall at all times hereinafter well and sufficiently indemnify and keep indemnified the Purchaser, his successors and assignee for an amount -----(25% of the value of stores supplied) from and against such damages, loss and costs, charges and expenses, whatsoever that may be caused and incurred by the said HORCL Administration on account of the short or non-receipt of the said stores said to have been dispatched by the said Way Bill No .----- to the said consignee or on account of the said goods if delivered in whole or in part not being according to the specification and requirements of the said contract and in the event of such short or non-delivery or delivery of the goods in whole or in the part being not in accordance with the specifications and requirements of the contract, the Supplier shall pay to the purchaser on intimation to the amount as may be equal to the price of the said goods so short received or not being according to the specifications or requirements as aforesaid and also all other loss that the Purchaser may incur or suffer on account thereof the decision of ----- HORCL as to the exact amount of such loss including the price of the goods short delivered or of the goods but not in accordance with the specifications or requirements of the said contract as aforesaid being final and binding on the Supplier together with all costs, charges and expenses that the Purchaser may incur for the recovery of the said amount and loss.

AND IT IS HEREBY guaranteed by the Supplier that PSC Sleepers which the Supplier has supplied have been manufactured fully in accordance with the specifications and its design shall strictly follow the “as made” detailed drawing with such specifications as are notified in respect of each type. The Supplier further guarantees that the PSC Sleeper shall be free from defects in material and workmanship. The Supplier shall be liable to arrange the necessary replacements of the defective sleepers free of any charge only to the extent that such replacements are attributable to or arise from faulty workmanship or material or design in the manufacture of the sleepers. All replacements shall be made free of cost at destination. If the Supplier so desires, the replaced sleepers can be taken over by him for disposal as he deems fit, within a period of three months from the date of receipt of the replacement of defective sleepers by the purchaser. At the expiry of this period, no claim in this respect shall lie on the purchaser.

IT IS AGREED that any approval or acceptance by the purchaser of the sleepers or of the materials incorporated therein shall not in any way limit the Supplier’s liability hereunder. The decision of the purchaser in regard to Supplier’s liability under this guarantee shall be final and conclusive. All replacements that the purchaser shall call upon the Supplier to deliver under this guarantee shall be delivered by the Supplier

within three months from the date of intimation of such rejection of defective sleepers. If the Supplier fails to replace the defective sleepers within the said period, the cost of the said sleepers at the rate stipulated in the contract shall be recovered from the payments due to the Supplier.

WHEREAS IT IS AGREED that the guarantee herein contains shall expire in respect of each sleeper on the expiry of 5 years from the date of the delivery or 3 years from the date of its placing in service whichever is earlier except in respect of defects notified to the Supplier prior to the expiry of such date.

9. AND IT IS HEREBY agreed between the parties hereto that the Purchaser shall be entitled to recover or adjust the cost of such replacements as aforesaid or the guaranteed amount----- (25% of the price of stores supplied) whichever is less out of or from the moneys, if any, payable to the Supplier in respect of the said Contract or any other contracts subsisting between the Supplier and the purchaser.

10. IN WITNESS WHEREOF the Supplier has put his seal on -----
--

IS HEREINTO affixed pursuant to a resolution, dated
passed by the Board of Directors of the said Company in the presence of:

1. Shri

2. Shri ...

M/s. _____

Signature of the Supplier
Firm's Name:

(Stamp)

Witness:

1)

2)

HORCL

FOR AND ON BEHALF OF HORCL

FINANCIAL PART (PDF FILE)
To be signed and uploaded with BOQ (MS Excel File) as FINANCIAL PART of the Tender by the Tenderer.

Letter of Tender – Financial Part

INSTRUCTIONS TO TENDERERS: DELETE THIS BOX ONCE YOU HAVE COMPLETED THE DOCUMENT

The Tenderer must prepare this Letter of Tender on stationery with its letterhead clearly showing the Tenderer's complete name and business address.

Note: All italicized text is to help Tenderers in preparing this form.

Date of this Tender submission: [*insert date (as day, month and year) of Tender submission*]

Tender No.: HORC/HRIDC/PSC-01/2023

To:

GM/IP&IT,

Haryana Rail Infrastructure Development Corporation Limited (HRIDC),
Plot no.143, 5th floor,
Railtel Tower, Sector-44
Gurugram – 122003

Tel: +91 7011056770

We, the undersigned, hereby submit the second part of our Tender, the Tender Price and Price Schedule. This accompanies the Letter of Tender – Technical Part.

In submitting our Tender, we declare that:

- (a) **Tender Validity Period:** Our Tender shall be valid for the period specified in TDS 18.1 (as amended, if applicable) after the date fixed for the Tender submission deadline specified in TDS 22.1 (as amended, if applicable), and it shall remain binding upon us and may be accepted at any time before the expiration of that period;
- (b) ****Tender Price:** The total price of our Tender is: [*insert the total price of the Tender in words and figures in INR*];
- (c) **Commissions, Gratuities, Fees:** We have paid, or will pay the following commissions, gratuities, or fees with respect to the Tendering process or execution of the Contract: [*insert complete name of each Recipient, its full address, the reason for*

which each commission or gratuity was paid and the amount and currency of each such commission or gratuity]

Name of Recipient	Address	Reason	Amount

(If none has been paid or is to be paid, indicate “none.”)

Name of the Tenderer: *[insert complete name of the Tenderer]*

Name of the person duly authorized to sign the Tender on behalf of the Tenderer:

**[insert complete name of person duly authorized to sign the Tender]*

Title of the person signing the Tender: *[insert complete title of the person signing the Tender]*

Signature of the person named above: *[insert signature of person whose name and capacity are shown above]*

Date signed *[insert date of signing]* **day of** *[insert month]*, *[insert year]*

*: Person signing the Tender shall have the power of attorney given by the Tenderer. The power of attorney shall be attached with the Letter of Tender.

Appendix A to Financial Part: Schedule of Adjustment Data

1. Price adjustment

- 1.1 The amounts payable to the Supplier for Works shall be adjusted in accordance with the provisions of this Clause 1.0, Sub-Clause 13.7 of GCC and Sub-Clause 13.7, Specific Provision, Part B, Section IX-PCC.
- 1.2 The Contract price shall include all duties (including Customs duties), taxes including Goods and Services Taxes (GST), insurances, transportation cost to the final destination (Project site), Inspection charges, Freight Charges, royalties, fees, cess, octroi/Entry tax, other levies payable by the Supplier under the Contract, or for any other cause, as of the date 28 days prior to the deadline for submission of Tenders shall be included in the rates, prices and the total Tender Price submitted by the Tenderer.
- 1.3 The prices charged for the Goods supplied and the related Services performed shall be adjustable.

Price Adjustment Formula

The following method shall be used to calculate the price adjustment:

$$P_1 = (P_0 / 100) (10 + 23 I_1 / I_0 + 11 L_1 / L_0 + 21 S_1 / S_0 + 26 C_1 / C_0 + 9 W_1 / W_0)$$

Where,

P₁	Updated Rate of sleeper
P₀	Accepted Rate of sleeper
I₁	WPI for Pig Iron during production Month as per Economic Advisor, Ministry of Industry web site http:// eaindustry.nic.in
I₀	WPI of Pig Iron for one month before tender opening month as per Economic Advisor, Ministry of Industry Web site http://eaindustry.nic.in
L₁	All India Consumer Price Index of Industrial Labour during production Month, as per Labour Bureau, Ministry of Labour web site http://labourbureau.nic.in
L₀	All India Consumer Price Index for Industrial Labour for one month before tender opening month as per Labour Bureau, Ministry of Labour web site http://labourbureau.nic.in

S₁	WPI for alloy steel wire rods during Production Month as per Economic Advisor, Ministry of Industry web site http:// eaindustry.nic. in
S₀	WPI for alloy steel wire rods for one month before tender opening month as per Economic Advisor, Ministry of Industry web site http:// eaindustry.nic. in
C₁	WPI for “Ordinary Portland Cement” during production month as per Economic Adviser, Ministry of Industry website http://eaindustry.nic.in/
C₀	WPI for “Ordinary Portland Cement” one month before tender opening month as per Economic Adviser, Ministry of Industry website http://eaindustry.nic.in/
W₁	WPI for all commodities during production Month as per Economic Advisor, Ministry of Industry web site http:// eaindustry.nic. in
W₀	WPI for all commodities for one month before tender opening month, as per Economic Advisor, Ministry of Industry web site http:// eaindustry.nic. in

1.4 In order to avoid blockage of funds till final escalation is worked out and paid on the basis of indices for the month of production, the accepted price will be updated every six months as per the above formula for escalation. First updating shall be done on the basis of indices for the month of acceptance of tender as soon as confirmed indices for the month of acceptance are available. Payment for the supplies made shall be done at the latest updated price.

1.5 No price adjustment shall be payable on the portion of the Contract Price paid to the Supplier as advance payment.

Table A. Foreign Currency (FC)

Not applicable as Tenderers are required to quote rates and prices only in INR.

Table B. Summary of Payment Currencies

For [insert name of Works]

Name of Payment Currency	A	B	C	D
	Amount of Currency	Rate of Exchange (local currency per unit of foreign)	Local Currency Equivalent $C = A \times B$	Percentage of Net Tender Price (NTP) $\frac{100 \times C}{NTP}$
Local currency (INR)		1.00		
Foreign Currency #1 _____				
Foreign Currency #2 _____				
Foreign Currency #3 _____				
Total Tender Price				100.00

Note: The Tenderer is required to propose and submit the schedules given in tables above as part of the Tender. The rates of exchange shall be the reference rate twenty-eight (28) days prior to the deadline for submission of Tenders published by the Reserve Bank of India (RBI) on its website <https://www.rbi.org.in> . In case the exchange rate of particular currency on given date is not available on RBI web site, it will be as per the web site <https://www.fbil.org.in> of Financial Benchmark India Private Limited (FBIL). In the case, where a Tenderer is required to convert a monetary amount from a currency other than those currencies for which the RBI/FBIL reference rate is not published, the INR equivalent shall be worked out using the rate of exchange as published by the central bank of the country issuing the said currency. In case the exchange rate of that currency is not directly available in INR on the website of the central bank of the country issuing the said currency then the currency will be first converted to USD as per that web site and then converted from USD to INR as Per RBI or FBIL reference rates.

Appendix B to Financial part: Bill of Quantities

1. Preamble

- 1.1. The Bill of Quantities shall be read in conjunction with the Instructions to Tenderers, the General Conditions, the Special Conditions and the Supply Requirements and the Addenda/Corrigenda (if any).
- 1.2. The quantities given in the Bills of Quantities are estimated and provisional and are given to provide a common basis for tendering. The basis of payment will be the actual quantities ordered and supply carried out, as measured by the Supplier and verified by the Engineer and valued at the rates and prices in the priced Bill of Quantities, where applicable, and otherwise at such rates and prices as the Engineer may fix within the terms of the Contract.
- 1.3. The supply of sleepers in accordance with the terms and conditions of this contract shall be at the accepted unit rate, subject to price adjustment in terms of SCC Para 15.1. In addition to the accepted rate the Supplier will also retain GST input credits available on input materials on the date of opening of the tender. GST input credit shall be covered under Clause 15.1.3 of Section IX-Special Conditions of Contract..”
- 1.4. The **quoted** rate shall be inclusive of the cost of all labour and all-inclusive cost of input materials (including cost of input freight if any) like HTS Wire, Inserts, Cement and coarse and fine aggregates, Fuel and Power etc., GST, including all handling charge and duties thereon.
 - 1.4.1. The **quoted** rate would also include the cost of transportation of finished sleepers to loading point and loading into the road vehicles in accordance with the approved drawing including the cost of handling involved in the process. The Cost of wooden packings as per drawings will be borne by the Supplier.
 - 1.4.2. The **quoted** rate would also include equated freight charge and other incidental charges for delivery up to consignee destination and unloading and stacking at destination (Approximate locations and approximate quantities of delivery have been given in Schedule of Requirement in Section VII-Schedule of Requirements). The Cost of wooden packings for stacking at the site of unloading as per drawings will be borne by the Supplier.
 - 1.4.3. The quoted rates shall be exclusive of inspection charges to be charged by inspecting Railway which will be paid by the HRIDC directly to inspecting Railway. However, third party inspection of all input materials required as per IRS Specification T-39 shall be arranged by the tenderer on the advice of inspecting Railway and inspection charges to be borne by the tenderer.
- 1.5. The supply of sleepers in accordance with the terms and conditions of this contract shall be at the accepted unit rate, subject to price variation in terms of Appendix A to

Financial Part: Schedule of Adjustment Data.

- 1.6. Statutory variation in GST will be applicable. The purchaser will, however, not be responsible for the reimbursement of any Taxes/Levies paid by the Supplier under misapprehension of law.
- 1.7. In the event of 'GST' input credit being extended by the Government of India to more items than those already covered on date of tender opening, the firm should advise the purchaser about the additional benefits accrued or any variation thereof, through a letter containing the following certificate.
- “We hereby declare that additional set-offs/Input tax credit to the tune of Rs..... has accrued and accordingly the same is being passed on to the purchaser and to that effect the payable amount may be adjusted.”
- 1.8. The Payment shall be made as per Clause 16 [Terms of Payment] of the General Conditions and Special Conditions of Contract.
- 1.9. The Purchaser shall make interim payments to the Supplier in accordance with the provisions of Sub-Clause 16.1 [Terms of Payment] of the General Conditions and Special Conditions of Contract, as certified by the Engineer.
- 1.10. The Supplier shall base its claim for interim payment in accordance with Sub-Clause 16.1 [Terms of Payment] of the General Conditions and Special Conditions for supplies completed till the end of the month, supported with documents and updated programme in accordance with the Supply Requirements.
- 1.11. Format for the Supplier's application for payment shall be agreed between the Engineer and the Supplier.
- 1.12. All necessary supplementary details to support delivery at destination, Railways test reports, input materials test reports, consignee receipt certificate etc. shall accompany an application for payment to be substantiated and certified by the Engineer and submitted to the Purchaser.
- 1.13. The Contract will remain current and valid for a stipulated delivery period including extensions if any, with effect from the date of acceptance of tender/counter offer, as the case may be. The Purchaser also has the right to defer deliveries (i.e. slow down supplies). The purchaser shall also have the right to enhance delivery period upto 12 months on the same rates, terms and conditions at its sole discretion.

2.0 Bill of Quantities

<u>Bill of Quantities</u>					
NAME OF WORK	PSC-01: Manufacture and Supply of Pre-stressed Mono Block Concrete Line Sleepers conforming to RDSO Drg. No. T-8746 in connection with laying of New BG Double Railway Line from Prithla to New Harsana Kalan of Haryana Orbital Rail Corridor (HORC) Project.				
Item No.	Item of Work	Unit	Quantity	Rate (Rs)	Amount (Rs)
1	Manufacture and Supply of Pre-stressed Mono Block Concrete Line Sleepers conforming to RDSO Drg. No. T-8746 in connection with laying of New BG Double Railway Line from Prithla to New Harsana Kalan of Haryana Orbital Rail Corridor (HORC) Project.	Nos.	5,27,400	4015.54	2,11,77,95,796.00
Total Estimated Amount (INR)					2,11,77,95,796.00